

## Series 475

# Granville-Phillips<sup>®</sup> Series 475 Convectron<sup>®</sup> Vacuum Measurement Controller



## Instruction Manual

*Instruction manual part number 475101*

*Revision A - November 2009*

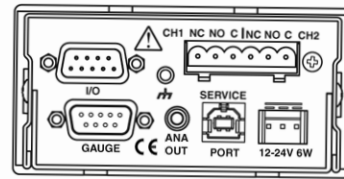
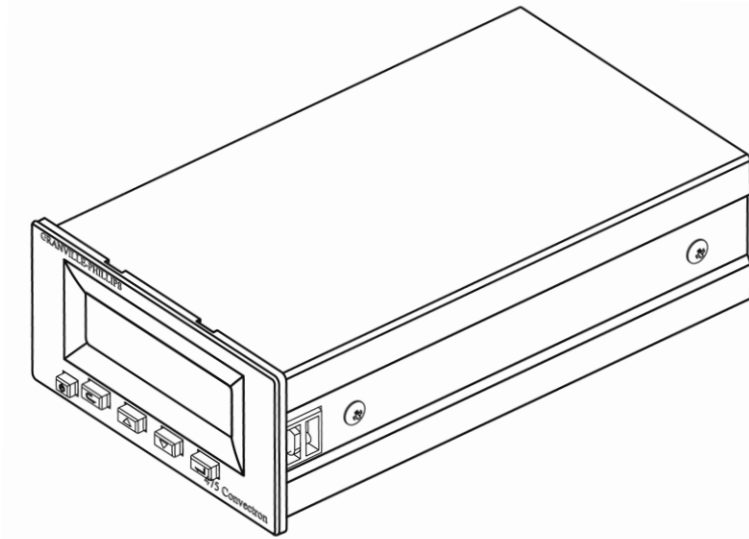

## Series 475

# Granville-Phillips® Series 475 Convector® Vacuum Measurement Controller

This Instruction Manual is for use with all Granville-Phillips Series 475 Vacuum Measurement Controllers. A list of applicable catalog numbers is provided on the following page.



### ***Customer Service/Support***

For customer service, 24 hours per day, 7 days per week, every day of the year including holidays, toll-free within the USA, phone +1-800-367-4887

For customer service within the USA, 8 AM to 5 PM, Mountain Time Zone weekdays, excluding holidays:

- Toll-free phone: +1-800-776-6543
- Phone: +1-303-652-4400
- FAX: +1-303-652-2844
- Email: [co-csr@brooks.com](mailto:co-csr@brooks.com)
- World Wide Web: [www.brooks.com](http://www.brooks.com)

## Instruction Manual

# Granville-Phillips Series 475 Convectron Vacuum Measurement Controller

**Catalog numbers for Series 475 Convectron Vacuum Measurement Controller with Graphic Display**  
 1/8 DIN Panel Mount or Benchtop Mount

**Controller:**

1/8 DIN Panel Mount or Benchtop Mount

475001 - X - X

**Interface / Setpoint Options:**

- None
- RS-232 with 2 Setpoints

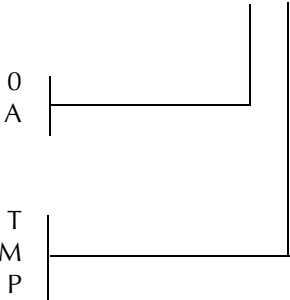

**Measurement Units:**

- Torr
- mbar
- Pascal

**Power Supply:**

Universal, CE Compliant

475008 - X

**Power Cords:**

- North American 115 VAC & Japan 100 VAC
- North American 240 VAC
- Universal Europe 220 VAC
- United Kingdom 240 VAC

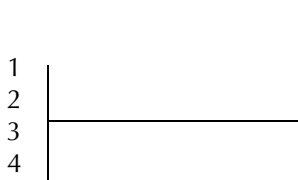

**Convectron Gauge Sensor Types by Catalog Number**

**Gold-plated Tungsten**

- 275071
- 275154
- 275168
- 275185
- 275196
- 275203
- 275233
- 275238
- 275256
- 275282
- 275316

**Platinum**

- 275320-x

ConFlat is a registered trademark of Varian Associates.  
 CAJON, VCO, and VCR are registered trademarks of Swagelok Company.

# Table of Contents

<b>Chapter 1</b>	<b>Safety</b> .....	<b>9</b>
1.1	Caution and Warning Statements .....	9
1.2	Reading and Following Instructions .....	9
1.3	System Grounding .....	10
1.4	Explosive Gases .....	10
1.5	Explosion / Implosion .....	10
1.6	Overpressure Conditions .....	10
1.7	Operation .....	11
1.8	Damage Requiring Service .....	11
1.9	Customer Service .....	11
<b>Chapter 2</b>	<b>Installation</b> .....	<b>13</b>
2.1	System Components .....	13
2.2	Pre-Installation Considerations .....	15
2.3	Installation Procedure .....	15
2.4	Install Pressure Relief Devices .....	16
2.5	Mount the Controller .....	16
2.6	Install the Convectron Gauge .....	18
	Install Vacuum Chamber Fittings .....	19
	Ground the Convectron Gauge .....	20
2.7	Connect the Wiring .....	20
2.8	Connectors .....	22
2.9	Configure the Relays for the Application .....	23
2.10	Requirements for Process Control Option .....	23
<b>Chapter 3</b>	<b>Operation</b> .....	<b>25</b>
3.1	Preparing for Pressure Measurement .....	25
3.2	Button Overview .....	25
3.3	Initial Power Up .....	25
3.4	Menu Overview .....	26
	Product Information .....	27
	Keypad .....	27
	Diagnose .....	27
	Calibrate .....	28
3.5	Configure .....	29
	Setpoint Parameters .....	29
	RS-232 Parameters .....	30
	Analog Output .....	30
	Pressure Units .....	31
	Display Options .....	31
	Gas Species .....	32
	Pressure Filtering .....	33
	Restore Configuration .....	34
	Save Configuration .....	34
	Gauge Sensor Type .....	34
	Correction Factor Parameters .....	35
3.6	Error Codes .....	36
3.7	Preparing For Convectron Gauge Operation .....	37
3.8	Convectron Gauge Theory of Operation .....	37

3.9	Convectron Gauge Sensors . . . . .	38
3.10	Using Gases Other than N <sub>2</sub> or Air . . . . .	38
	Effects on User Calibration . . . . .	38
	Indicated vs. True Pressure for Gases Other Than N <sub>2</sub> or Air . .	39
	Examples . . . . .	40
3.11	Calibration . . . . .	48
	Calibration Ranges for Different Gas Species . . . . .	48
	Vacuum Calibration . . . . .	48
	Atmosphere Calibration . . . . .	48
	Convectron Gauge Use Below 10 <sup>-3</sup> Torr . . . . .	49
	NIST Traceable System Calibration . . . . .	49
3.12	Convectron Gauge Analog Output Signal . . . . .	50
	Default Analog Output of 0 to 7 V . . . . .	52
	Optional Analog Output of 1 to 8 V . . . . .	52
	Optional Nonlinear Analog Output “S Curve” . . . . .	52
3.13	Analog Output Mode Programming . . . . .	52
3.14	Process Control Setpoints & RS-232 . . . . .	52
<b>Chapter 4</b>	<b>Process Control . . . . .</b>	<b>53</b>
4.1	Process Control Setup . . . . .	53
4.2	Connecting Process Control Relays . . . . .	54
4.3	Setpoint Display and Adjustment . . . . .	54
4.4	Process Control Tips . . . . .	55
4.5	Process Control Factory Default Settings . . . . .	55
4.6	Process Control Relay Trip Points . . . . .	56
<b>Chapter 5</b>	<b>RS-232 Interface . . . . .</b>	<b>57</b>
5.1	RS-232 Theory of Operation for the 475 Controller . . . . .	57
5.2	Connecting the RS-232 Computer Interface . . . . .	57
5.3	RS-232 Handshake . . . . .	58
5.4	Command–Response Timing . . . . .	59
5.5	Preparing the RS-232 Computer Interface . . . . .	60
5.6	RS-232 Command Syntax . . . . .	61
5.7	RS-232 Troubleshooting . . . . .	72
	RS-232 Error Messages . . . . .	72
<b>Chapter 6</b>	<b>Diagnostics . . . . .</b>	<b>73</b>
6.1	Continuous Diagnostics . . . . .	74
6.2	Diagnostics Requiring User Interaction . . . . .	74
	Analog Output . . . . .	74
	Measurement Circuits . . . . .	74
6.3	Convectron Gauge Simulator . . . . .	75
	Simulate a Process Operation Prior to Full System Integration .	75
	Analog Output Tests . . . . .	76
	Controller Calibration Verification . . . . .	76

---

<b>Chapter 7</b>	<b>Service and Maintenance</b> .....	<b>77</b>
	7.1 Customer Service .....	77
	7.2 Service Guidelines .....	77
	7.3 Damage Requiring Service .....	77
	7.4 Error Codes and Possible Solutions .....	79
	7.5 RS-232 Troubleshooting .....	80
	7.6 Convectron Gauge Test Procedure .....	81
	7.7 Cleaning Contaminated Convectron Gauges .....	81
	7.8 Reset the Factory Defaults .....	82
	7.9 Returning a Damaged Controller .....	82
	7.10 Specifications .....	83
<b>Index</b> .....		<b>85</b>



## 1.1 Caution and Warning Statements

This manual contains caution and warning statements with which you *must* comply to prevent inaccurate measurement, property damage, or personal injury.



### CAUTION

**Caution statements alert you to hazards or unsafe practices that could result in minor personal injury or property damage.**

Each caution statement explains what you *must* do to prevent or avoid the potential result of the specified hazard or unsafe practice.



### WARNING

**Warning statements alert you to hazards or unsafe practices that could result in severe personal injury or death due to electrical shock, fire, or explosion.**

Each warning statement explains what you *must* do to prevent or avoid the potential result of the specified hazard or unsafe practice.

Each caution or warning statement explains:

1. The specific hazard that you *must* prevent or unsafe practice that you *must* avoid,
2. The potential result of your failure to prevent the specified hazard or avoid the unsafe practice, and
3. What you *must* do to prevent the specified hazardous result.

## 1.2 Reading and Following Instructions

You must comply with all instructions while you are installing, operating, or maintaining the controller. Failure to comply with the instructions violates standards of design, manufacture, and intended use of the controller. Granville-Phillips and Brooks Automation disclaim all liability for the customer's failure to comply with the instructions.

- Read instructions – Read all instructions before installing or operating the controller.
- Retain instructions – Retain the instructions for future reference.
- Follow instructions – Follow all installation, operating and maintenance instructions.
- Heed warnings and cautions – Adhere to all warnings and caution statements on the controller and in these instructions.
- Parts and accessories – Install only those replacement parts and accessories that are recommended by Granville-Phillips. Substitution of parts is hazardous.

 **WARNING**

**Read these safety notices and warnings before installing, using, or servicing this equipment. If you have any doubts regarding the safe use of this equipment, contact the Granville–Phillips Customer Service department at the address listed in this user manual.**

Each warning statement explains what you *must* do to prevent or avoid the potential result of the specified hazard or unsafe practice.

**1.3 System Grounding**

Ion producing equipment, such as ionization gauges, mass spectrometers, sputtering systems, etc., from many manufacturers may, under some conditions, provide sufficient electrical conduction via a plasma to couple a high voltage electrode potential to the vacuum chamber. If exposed conductive parts of the gauge, controller, and chamber are not properly grounded, they may attain a potential near that of the high voltage electrode during this coupling. Potential fatal electrical shock could then occur because of the high voltage between these exposed conductors and ground.

All components in a vacuum system used with this or any similar high voltage product must be maintained at Earth ground for safe operation. Connect power cords only to properly grounded outlets or sources.

**1.4 Explosive Gases**

Do not use the Series 475 Controller or a Series 275 Convectron Gauge in an environment of explosive or combustible gases or gas mixtures. Operation of any electrical instrument in such an environment constitutes a definite safety hazard. Do not use the product to measure the pressure of explosive gases or gas mixtures. The sensor wire of a Convectron gauge normally operates at 125 degrees Centigrade. If a malfunction causes the sensor wire to reach a higher temperature, it could raise the sensor wire temperature to above the ignition point of combustible materials or gases.

Danger of explosion or inadvertent venting to atmosphere exists in all vacuum systems which incorporate gas sources or involve processes capable of pressuring the system above safe limits.

**1.5 Explosion / Implosion**

Danger of injury to personnel and damage to equipment exists on all vacuum systems that incorporate gas sources or involve processes capable of pressuring the system above the limits it can safely withstand.

For example, danger of explosion in a vacuum system exists during backfilling from pressurized gas cylinders because many vacuum devices such as ionization gauge tubes, glass windows, glass belljars, etc., are not designed to be pressurized.

**1.6 Overpressure Conditions**

Do NOT subject Series 275 Convectron gauges to pressures above 1000 Torr.

Install suitable devices that will limit the pressure from external gas sources to the level that the vacuum system can safely withstand. In addition, install suitable pressure relief valves or rupture disks that will release pressure at a

level considerably below that pressure which the system can safely withstand.

Suppliers of pressure relief valves and pressure relief disks are listed in Thomas Register under "Valves, Relief", and "Discs, Rupture".

Confirm that these safety devices are properly installed before installing the Series 275 Convector gauge. In addition, check that (1) the proper gas cylinders are installed, (2) gas cylinder valve positions are correct on manual systems, and (3) the automation is correct on automated systems.

Using the N<sub>2</sub> calibration to pressurize a vacuum system above 1 Torr with certain other gases can cause dangerously high pressures which can cause explosion of the system. See *Indicated vs. True Pressure for Gases Other Than N<sub>2</sub> or Air* on page 39.

If used improperly, Convector gauges can supply misleading pressure indications that can result in dangerous overpressure conditions within the system.

## 1.7 Operation

It is the installer's responsibility to ensure that the automatic signals provided by the process control module are always used in a safe manner.

Carefully check manual operation of the system and the setpoint programming before switching to automatic operation. Where an equipment malfunction could cause a hazardous situation, always provide for fail-safe operation. As an example, in an automatic backfill operation where a malfunction might cause high internal pressures, provide an appropriate pressure relief device.

## 1.8 Damage Requiring Service

*Turn OFF power to the controller* and refer servicing to qualified service personnel under the following conditions:

- If any liquid has been spilled onto, or objects have fallen into, the controller.
- If a circuit board is faulty.
- If the Convector gauge sensing wire is open or the gauge is contaminated.
- If the controller has been exposed to moisture.
- If the controller does not operate normally even if you follow the operating instructions. Adjust only those controls that are explained in this instruction manual. Improper adjustment of other controls may result in damage and will often require extensive work by a qualified technician to restore the controller to its normal operation.
- If the controller has been dropped or the enclosure has been damaged.
- If the controller exhibits a distinct change in performance.

## 1.9 Customer Service

- Phone **+1-303-652-4400** or **+1-800-776-6543**, 8:00 AM to 5:00 PM Mountain Time Zone weekdays, excluding holidays within the USA.
- Phone **+1-800-367-GUTS (+1-800-367-4887)** 24 hours per day, seven days per week within the USA.
- Email [co-csr@brooks.com](mailto:co-csr@brooks.com)

NOTES:

## 2.1 System Components

Figure 2-1 and Figure 2-2 illustrate all available options and system capabilities, including controllers with process control and RS-232 computer interface options.

**Figure 2-1 Series 475 Convectron Controller Front and Rear Panels**

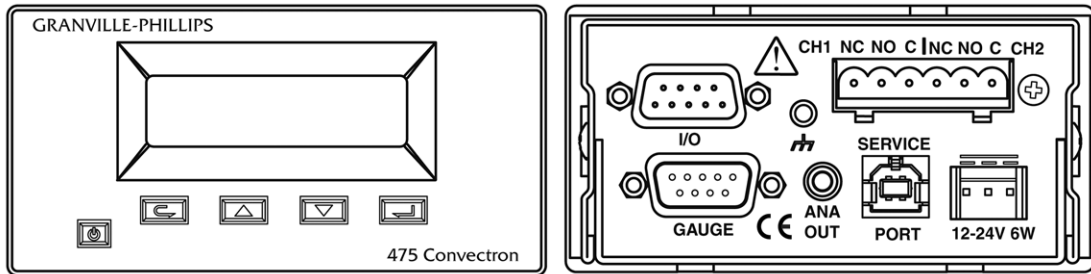

**Figure 2-2 Convectron Vacuum Measurement System Components**

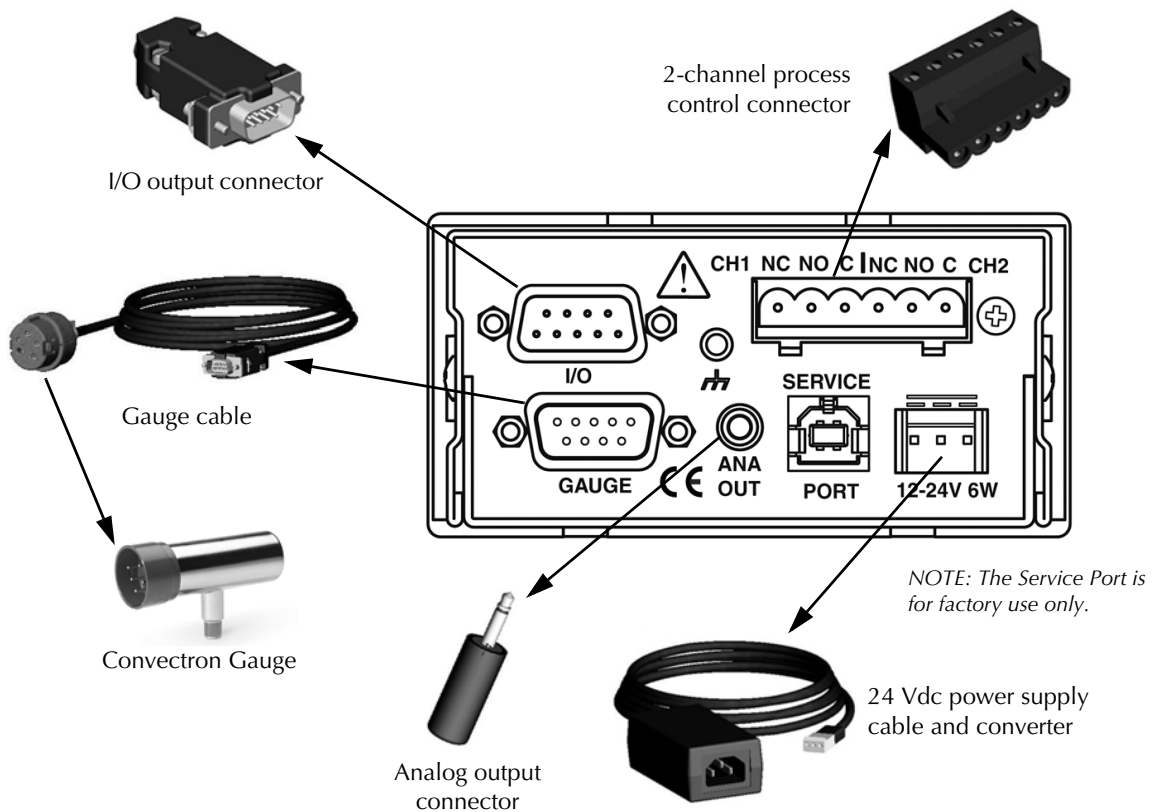

**Table 2-1 475 Controller Factory Defaults**

Setting	Range or Selection	Factory Default Setting
Units of Measure	Torr, mbar, pascal	Torr, mbar, or pascal as selected when the Controller was purchased.
Maximum Pressure	1E-3 Torr to 999 Torr	999 Torr
Gas Species	N <sub>2</sub> , Ar, O <sub>2</sub> , He, CO <sub>2</sub> , FS, CF	N <sub>2</sub>
Front Panel Display		
• Brightness	1, 2, or 3	3 (Bright)
• Setpoints displayed	Yes, No	No
Gauge Sensor	Gold-Tungsten, Platinum	Gold-Tungsten
SetPoints/Outputs		
• SP1 Pressure	1E-4 Torr to 1000 Torr	1.00E-4
• SP2 Pressure	1E-4 Torr to 1000 Torr	1.00E-4
• SP1 Hysteresis	5 to 1000 percent	10
• SP2 Hysteresis	5 to 1000 percent	10
• SP1 Polarity	Normal, Reverse	Normal
• SP2 Polarity	Normal, Reverse	Normal
• SP1 Enable	Disable, Enable	Disable
• SP2 Enable	Disable, Enable	Disable
• Analog Out Mode	Log 0-7V, Log 1-8V, S-curve	Log 0V-7V
• Analog Out Offset	0.0V to 0.5V	0V
Correction Factor	0.1 to 1.5	None
Low-Pass Filter (LPF)	Disable, Enable	Enable
Pressure Response Delay (ms)	0 to 200 ms	0 ms
RS-232		
• Baud Rate / Format	Baud Rate: 1200, 2400, 4800, 9600, 19200, 38400 Bits: • 8N1 (8 data bits, No parity, 1 stop bit) • 7E1 (8 data bits, Even parity, 1 stop bit) • 7O1 (8 data bits, Odd parity, 1 stop bit)	19200 baud, 8 data bits, No parity, 1 stop bit, RTS/CTS disabled
• Hardware Handshake	Disable, Enable	Disable

## 2.2 Pre-Installation Considerations

This chapter guides you through the basic setup procedures for the 475 Controller, including mounting the Controller, installing a Convector gauge, connecting vacuum chamber fittings, and connecting wiring.

If your application requires different settings than the factory defaults listed in Table 2-1, see Chapters 3, 4, and 5 for instructions on changing the settings. You can reconfigure options before or after completing the basic setup procedures described in this chapter.

### **WARNING**

**Installing, removing, or replacing the 475 Controller in a high-voltage environment can cause an electrical discharge through a gas or plasma, resulting in property damage or personal injury due to electrical shock or fire.**

Vent the vacuum chamber to atmospheric pressure and shut off power to the controller before you install, remove, or replace the controller.

### **WARNING**

**Exposing the controller to moisture can cause fire or electrical shock resulting in product damage or personal injury.**

To avoid exposing the controller to moisture, install the controller in an indoor environment. Do not install the controller in any outdoor environment. Do not spill any liquid onto the controller.

## 2.3 Installation Procedure

The controller installation procedure includes the following steps:

1. Install the appropriate pressure relief devices in the vacuum system.
2. Establish the desired location and orientation for the Series 475 Controller.
3. Install the Convector gauge that connects to the Controller.
4. Assemble and connect the Controller wiring.
5. Adjust the process control relays for the process pressures that will be used.

## 2.4 Install Pressure Relief Devices

Before you install the Controller, install appropriate pressure relief devices in the vacuum system.

Granville-Phillips does not supply pressure relief valves or rupture disks. Suppliers of pressure relief valves and rupture disks are listed in the *Thomas Register* under "Valves, Relief" and "Discs, Rupture."

### CAUTION

**Operating the controller above 1000 Torr (1333 mbar, 133 kPa) true pressure could cause pressure measurement error or product failure.**

To avoid measurement error or product failure due to overpressurization, install pressure relief valves or rupture disks in the system if pressure exceeds 1000 Torr (1333 mbar, 133 kPa).

## 2.5 Mount the Controller

To locate and orient the Controller, refer to Figure 2-3 and follow the instructions below.

- For greatest accuracy and repeatability, locate the Controller in a stable, room-temperature environment. Ambient temperature should never exceed 40 °C (104 °F) operating, non-condensing, or 85 °C (185 °F) non-operating.
- Provide adequate ventilation for the Controller to dissipate 6 Watts.
- Locate the Controller away from internal and external heat sources and in an area where ambient temperature remains reasonably constant.
- Do not locate the Controller where it will be exposed to corrosive gases such as mercury vapor or fluorine.

See *Install the Convectron Gauge* on page 18 for Convectron gauge installation instructions.

Figure 2-3 Controller Dimensions

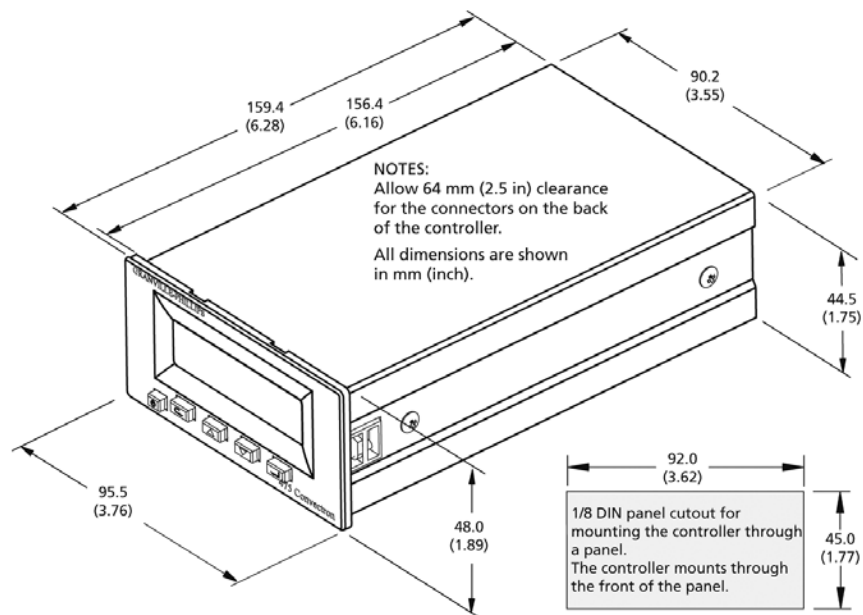

The Controller may be free-standing or panel-mounted. For free standing (benchtop) use, install the provided self-adhesive rubber feet on the bottom of the controller.

**To use the Controller in a free-standing (benchtop) configuration:**

1. Apply the four provided adhesive rubber mount feet on the bottom of the controller.

**Figure 2-4 Mount Feet on the Bottom of the Controller**

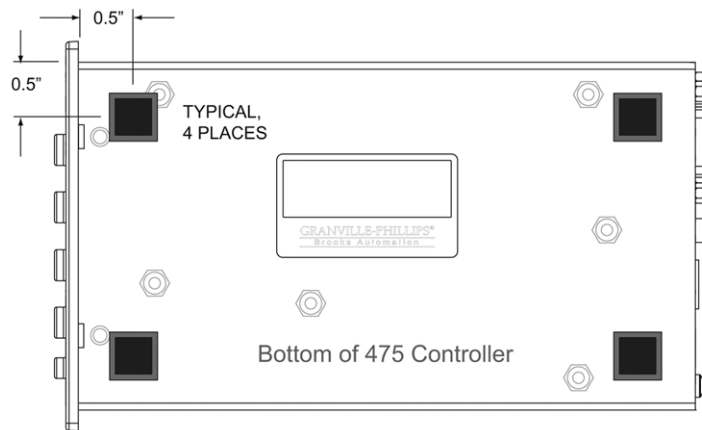

**To mount the controller in a panel,** refer to Figure 2-5 and Figure 2-6, and follow these steps:

- Panel opening dimensions are 92 mm x 45 mm (3.6 inches x 1.77 inch).
  - Panel thickness is 3 mm (1/8 inch).
  - Provide a minimum of 64 mm (2.5 inch) clearance behind the controller to allow for cables.
1. Prepare the panel opening per the dimensions listed on Figure 2-3 and the bullet points listed above.
  2. Remove the Front Panel (bezel) as shown in Figure 2-5. Hold the Controller in your hands and use your thumbs to push on the bezel. Push the bottom of the bezel loose, then the top.

**Figure 2-5 Remove the Front Panel (bezel)**

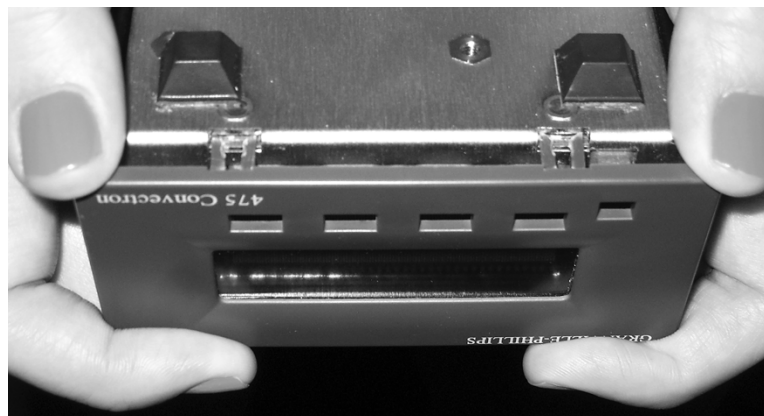

3. Insert the Controller through the front of the panel.

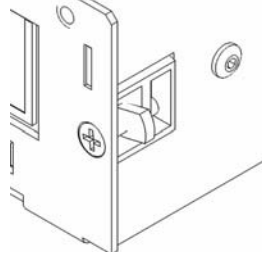
**Figure 2-6 Pawl Screw Used to Secure Controller to Panel**

4. Use a Phillips head screwdriver to rotate the Pawl Screw to lock the Controller to the panel. See Figure 2-6.
5. Replace the bezel by aligning it with the keys and push the top and the bottom of the bezel to snap it into place.

## 2.6 Install the Convectron Gauge

To install Convectron gauges, refer to Figure 2-7 and follow the instructions below.

- Orient the Convectron gauge to prevent condensation of process vapors on the internal surfaces through line-of-sight access to its interior. If vapor condensation is likely, orient the port downward to help liquids drain out.
- For proper operation above about 1 Torr, install Convectron gauges with the gauge axis horizontal.

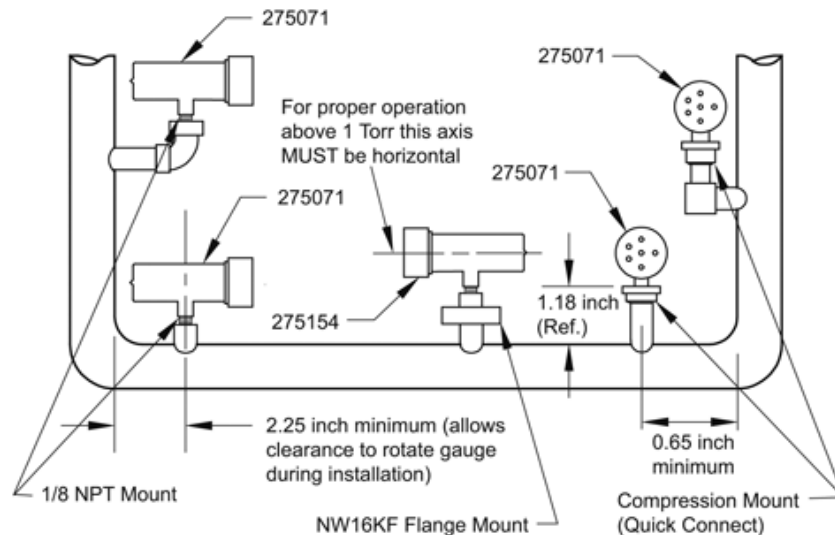
**Figure 2-7 Convectron Gauge Installation**

- Do not locate the Convectron gauge near the pump, where gauge pressure might be lower than normal vacuum pressure.
- Do not locate the gauge near a gas inlet or other source of contamination, where inflow of gas or particulates causes atmospheric pressure to be higher than system atmosphere.
- Do not locate the gauge where it will be subjected to vibration, which causes convection cooling, resulting in inaccurate high pressure readings.
- Do not locate the gauge where it will be subjected to extreme temperature fluctuations. For greatest accuracy and repeatability the gauge should be located in a stable room temperature environment.

## Install Vacuum Chamber Fittings

Do not use a compression mount/quick connect fitting for positive pressure applications. The gauge may be forcefully ejected. The gauge port fits a standard 1/2-inch compression/quick connect mounting such as an Ultra-Torr® fitting.

### WARNING

**Failure to install appropriate pressure relief devices for high-pressure applications can cause product damage or personal injury.**

For automatic backfilling and other applications in which malfunction or normal process conditions can cause high pressures to occur, install appropriate pressure relief devices.

### 1/8 NPT Pipe Thread



The 1/8 NPT pipe thread accommodates a standard 1/8 NPT female fitting.

1. Wrap the threads of the port to the vacuum chamber with Teflon® tape.
2. Tighten the gauge just enough to achieve a seal. Do NOT over tighten.

### VCR Type Fitting

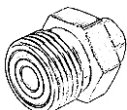

1. Remove the plastic or metal bead protector cap from the fitting.
2. If a gasket is used, place the gasket into the female nut.
3. Assemble the components and tighten them to finger-tight.
4. While holding a back-up wrench stationary, tighten the female nut 1/8 turn past finger-tight on 316 stainless steel or nickel gaskets, or 1/4 turn past finger-tight on copper or aluminum gaskets.

### KF Flange



The KF mounting system requires O-rings and centering rings between mating flanges.

1. Tighten the clamp wing nut to compress the mating flanges together.
2. Seal the O-ring.

### ConFlat Flange

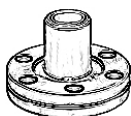

To minimize the possibility of leaks with ConFlat flanges, use high strength stainless steel bolts and a new, clean OFHC copper gasket. Avoid scratching the seal surfaces. To avoid contamination, install metal gaskets.

1. Finger tighten all bolts.
2. Use a wrench to continue tightening 1/8 turn at a time in criss-cross order (1, 4, 2, 5, 3, 6) until the flange faces make contact. Further tighten each bolt about 1/16 turn.

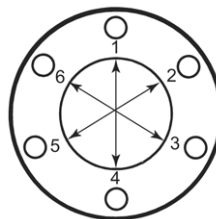

**Ground the Convectron Gauge**

- If the Convectron Gauge has a VCR type fitting or ConFlat flange, it will be properly grounded via the vacuum chamber connection.
- If the Convectron Gauge has a KF flange or an NPT fitting, use a length of #12 AWG braided copper wire which connects to the Convectron Gauge and to the vacuum chamber ground connection. See Figure 3.

**⚠ WARNING**

**Improper grounding could cause product failure or personal injury.**

- Follow ground network requirements for the facility.
- Maintain all exposed conductors at earth ground.
- Make sure the vacuum port to which the gauge is mounted is properly grounded.

**Figure 2-8 Convectron Gauge to Vacuum Chamber Ground Connection**



**2.7 Connect the Wiring**

The 475 Controller has connectors for Convectron gauge cable, RS-232, setpoints, analog output cable, and power supply wiring, as illustrated in Figure 2-9 (shown with the optional RS-232 and setpoint connectors).

**Figure 2-9 Convectron Gauge, Output, and Power Connections**

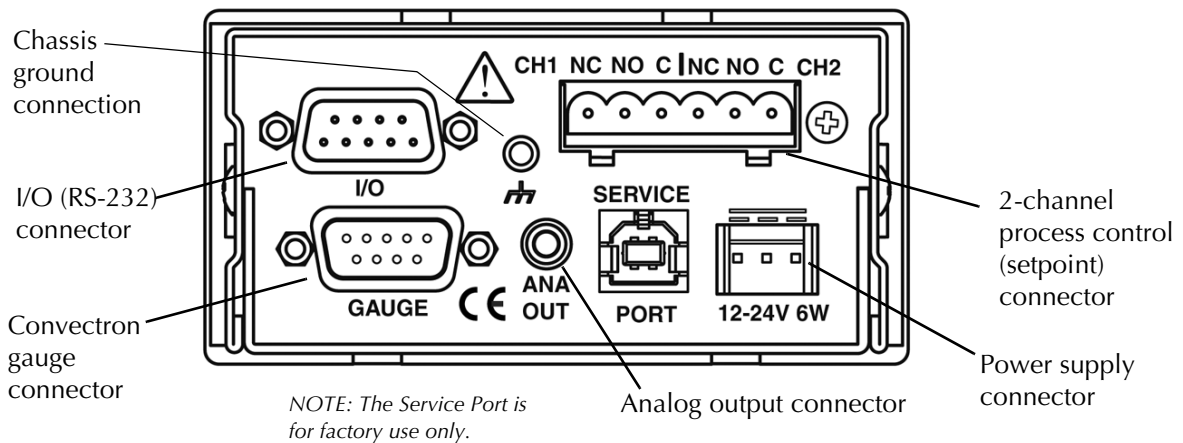

- Connect a #12 AWG ground wire to the chassis ground connection on the rear of the Controller and to a known Earth ground. Do NOT connect a ground wire from the Controller directly to the vacuum chamber or system ground.

 **WARNING**

**Improper grounding can cause product damage or personal injury.**

Follow ground network requirements for the facility.

- Maintain all exposed conductors at earth ground.
- Connect the power cord to a properly grounded outlet.
- Make sure the vacuum port to which the gauge is mounted is properly grounded.
- Connect the gauge envelope to a facility ground or shield the envelope. If necessary, use a ground lug on the flange bolt. Ground the gauge envelope by using a metal hose clamp on the gauge connected by a #12 AWG (minimum size) copper wire to the grounded vacuum chamber.

- Connect the Convectron gauge cable between the gauge and the controller. See Figure 2-9.
- Connect the power supply by inserting the power cord with the locking tab up. See Figure 2-10.

*NOTE: The 475 Controller is internally limited to 28 Vdc maximum and 1.4 A. Do not connect the input to high voltage.*

Power supply wiring depends on the power supply voltage and the type of mounting. There are two ways to supply power to the 475 Controller:

1. Use a CE-compliant power supply: 90 to 250 VAC input, 24 Vdc output, with connection plugs to accommodate the local AC plug type (catalog number 475008-1 through -4 -- See page 2 of this Instruction Manual).
2. User supplied power to the controller using a wire adapter and plug to connect to a 12 to 24 Vdc supply voltage (Granville-Phillips part number 167820). If you use the wire adapter, the wires to be connected to the user supplied power are marked on the end of the cable:

Outside: Supply ground for 12 to 24 Vdc power supply

Center: +12 to 24 Vdc power < 0.5 A @ 12 V (i.e. < 6 Watts) continuous (Inrush limited to < 1.4 A for < 7 msec)

Colored End: Safety chassis ground.

Both options accommodate the same orientation and connection plug. The locking tab mechanism is on the top side of the connector when you plug it into the rear panel. See Figure 2-10.

**Figure 2-10 Locking Tab for Power Supply Cord**

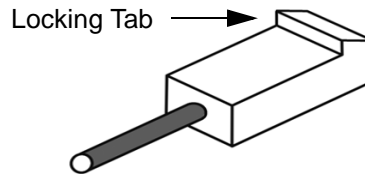

**2.8 Connectors**

The following figures illustrate the connectors on the back of the 475 Controller.

**Figure 2-11 I/O (RS-232) 9-Pin Connector (pins)**



**Figure 2-12 Convectron Gauge 9-Pin Connector (sockets)**

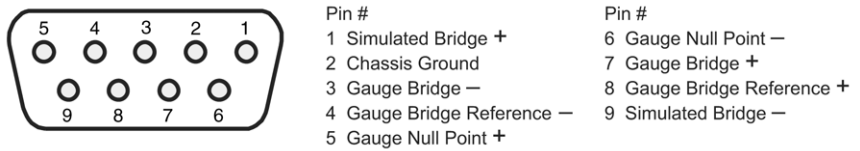

**Figure 2-13 2-Channel Process Control Connector (pins)**

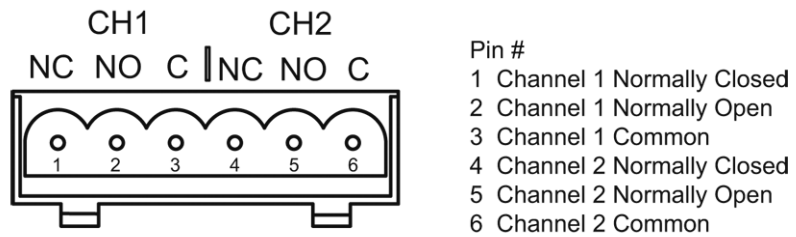

**Figure 2-14 Analog Output Connector (socket)**

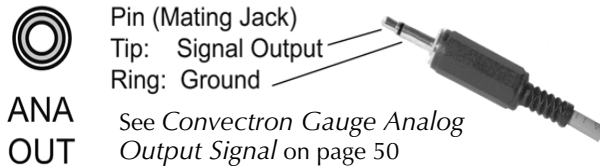

**Figure 2-15 3-Pin Power Supply Connector**

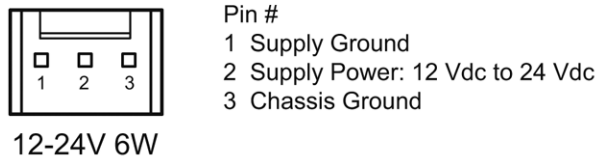

## 2.9 Configure the Relays for the Application

- To configure the setpoint relays for the process control option, see page 53.
- To configure the setpoint relays using the RS-232 option, see *PCE Relays* on page 66.

If the controller will measure the pressure of a gas other than N<sub>2</sub> or air, you *must* adjust relay setpoints for the process gas. The true pressure of a gas other than N<sub>2</sub> or air may be substantially different from the pressure that the output indicates. For example, outputs might indicate a pressure of 10 Torr (13.3 mbar, 1.33 kPa) for argon, although the true pressure of the argon is 250 Torr (333 mbar, 33.3 kPa). Such a substantial difference between indicated pressure and true pressure can cause over pressurization resulting in an explosion. See *Using Gases Other than N<sub>2</sub> or Air* on page 38 and *Gas Species* on page 32.



### WARNING

**Failure to use accurate pressure conversion data for N<sub>2</sub> or air to other gases can cause an explosion due to overpressurization.**

If the controller will measure any gas other than N<sub>2</sub> or air, before putting the controller into operation, adjust relays for the process gas that will be used.

## 2.10 Requirements for Process Control Option

If you are using the process control option, you must prepare for process control operation before turning ON the controller. See *Chapter 4* for complete process control setup instructions.



### CAUTION

**Failure to check system setup configuration before switching to automatic operation can cause errors.**

## NOTES:

## 3.1 Preparing for Pressure Measurement

Before you prepare for process measurement, make sure:

- The controller was properly set up and installed per the instructions in *Chapter 2*.
- The gas in your vacuum system is air or N<sub>2</sub>. If you are using other gases you must follow the instructions in *Using Gases Other than N<sub>2</sub> or Air* on page 38 and *Indicated vs. True Pressure for Gases Other Than N<sub>2</sub> or Air* on page 39.
- You are reasonably familiar with the general theory of operation of thermal conductivity gauges. See *Convectron Gauge Theory of Operation* on page 37.

**Figure 3-1 Series 475 Convectron Gauge Controller Front Panel**

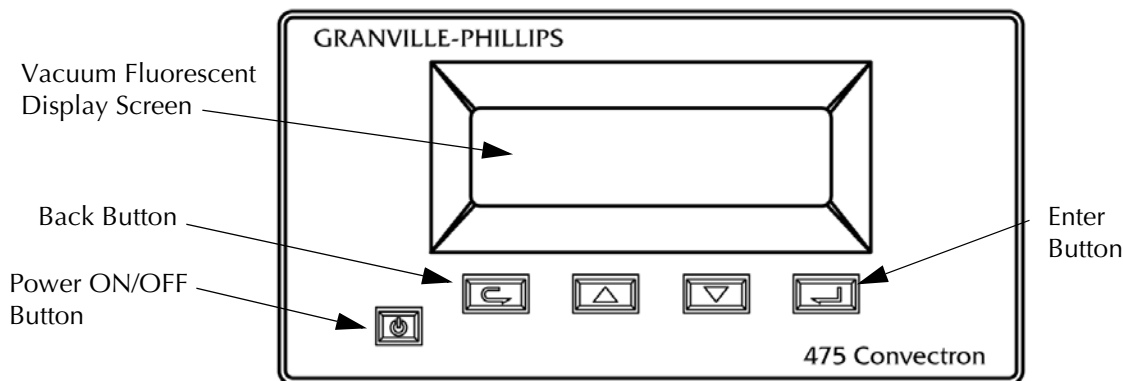

## 3.2 Button Overview



- The POWER button is press ON, press OFF. In case of power failure, the controller will restart if it was ON when power was interrupted.
- Use the BACK button to exit menus. 
- Use the UP and DOWN buttons to make menu selections and change parameter settings. 
- Use the ENTER button to enter menus and to execute parameter changes. 

Figure 3-2 page 26 illustrates the button menu flow.

## 3.3 Initial Power Up

1. Press the Power ON/OFF button (see Figure 3-1). The display screen will illuminate.
2. Run the self diagnostics tests to allow the 475 Controller to perform a self diagnostics test. See *Diagnose* beginning on page 27 to run the tests.

Figure 3-2 Series 475 Convector Gauge Controller System Menu Flowchart

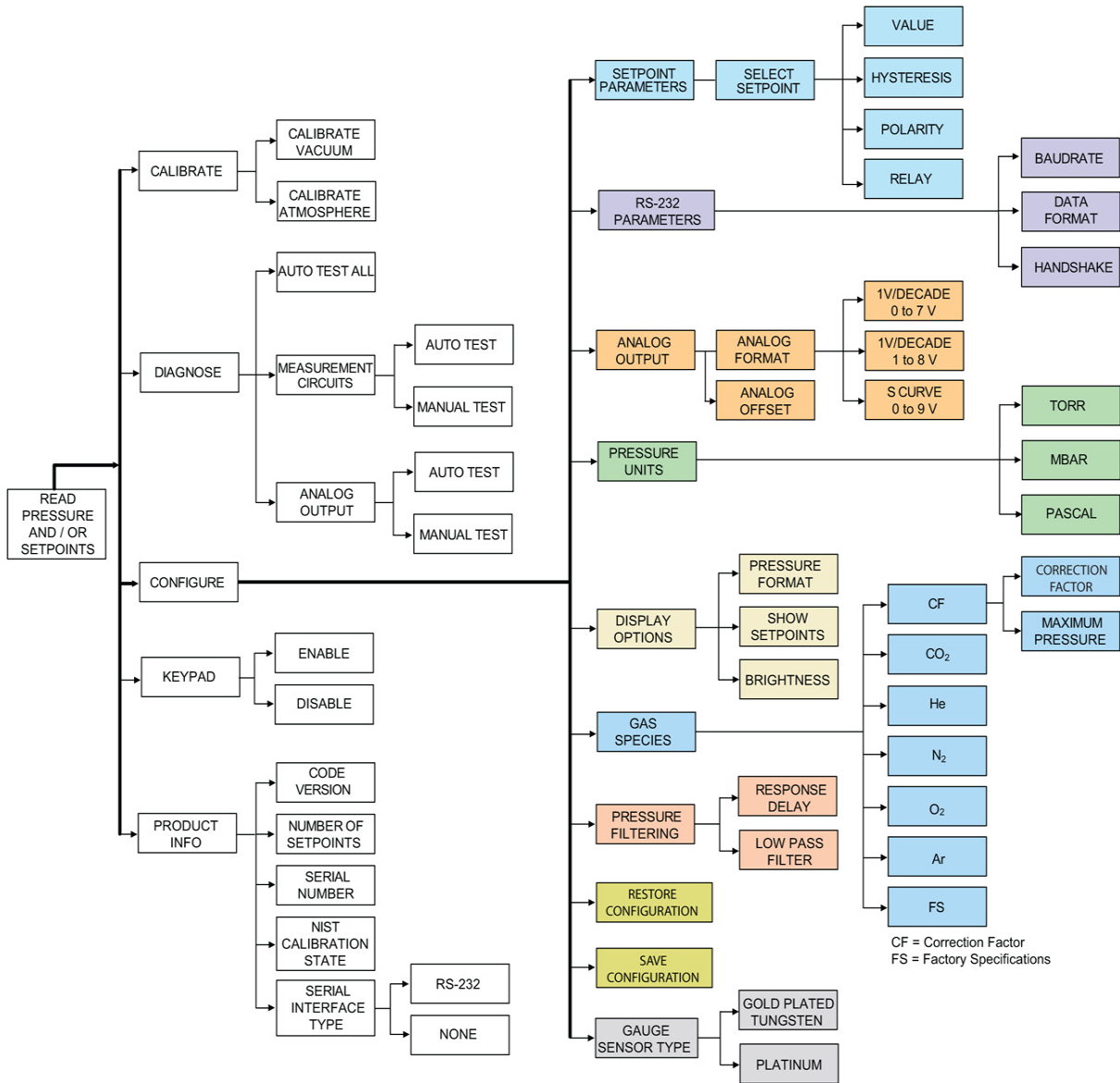

### 3.4 Menu Overview

All functions, settings, and options can be accessed and displayed by using the four buttons on the front panel of the controller. Some of the displayed settings are for information only, and others can be changed and saved. Use either the UP or DOWN button to scroll through the menu selections.

The five main menu selections are Calibrate, Configure, Diagnose, Keypad, and Product Info. See Figure 3-2. Each of these menu selections and their relevant sub-selections are explained in the following sections of this chapter.

When using a PC and the RS-232 option, additional information is provided in the Process Control Chapter and the RS-232 Chapter.

### 3.4.1 Product Information

Product information allows the user to read the product revision and installed options.

1. Press the UP or DOWN button to scroll to "Product Info" and press the ENTER button.
2. Press the UP or DOWN button to browse the product information.
3. "Code Version" displays the software part number and revision.
4. "Setpoints" displays the number of relays.
5. "Serial Number" is the same as the label on the product.
6. "NIST Calibration" displays "Yes" if the gauge and controller have been calibrated on NIST traceable instrumentation, or displays "No" if there's no NIST calibration or it has been voided. See *NIST Traceable System Calibration* on page 49 for more detailed information.
7. "Serial Interface" displays if the RS-232 serial interface is installed.
8. Press the BACK button a few times or wait one minute to return to pressure display.

### 3.4.2 Keypad

The keypad consists of five momentary switches; one is used as a power switch, four are used for user interaction with the display menu.

The keypad can be enabled or disabled.

Disabling the keypad prevents unwanted key presses (similar to the Series 375 lock switch). When disabled, any key press (EXCEPT the Power key) causes a "keypad disabled" notification to be shown for two seconds. The "current pressure screen" is shown by default.

1. Press the UP or DOWN button to scroll to "Keypad" and press the ENTER button.
2. Press the UP or DOWN button to select "Enable" or "Disable" and press the ENTER button.
3. Press the BACK button a few times or wait one minute to return to pressure display.
4. To re-enable the keypad, enter the sequence Up, Down, Back, Enter within five seconds.

### 3.4.3 Diagnose

During the diagnostics "Test Measurement" function, pressure reporting is suspended and the Convector simulator is switched ON. (See *Convector Gauge Simulator beginning on page 75*.) For the "Auto Test", the Convector simulator simulates five different equally-spaced Analog to Digital (A/D) voltages across the whole range (0.317 to 5.635V). These voltages are measured and compared by the external A/D and the internal microcontroller A/D. The Convector simulator is switched OFF, pressure reporting resumed, and a pass/fail is reported to the user. See *Chapter 6* for more information on the diagnostics.

The same process is used for the "Manual Test", except the user can enter either pressure or bridge voltage and pass/fail criteria is not determined by the microcontroller.

During the Analog Output diagnostic function, pressure reporting is suspended to the analog output, and the analog output is tested at discrete points between 0 V and 10.5 V.

1. Press the UP or DOWN button to scroll to "Diagnose" and press the

ENTER button.

2. Press the UP or DOWN button to select “Auto Test”, “Meas. Circuit”, or “Analog Output” and press the ENTER button.

- **Auto Test All**

Performs the “Auto Test” described above.

1. Press the ENTER button to allow the 475 Controller to automatically perform a self diagnostics test.

- **Test Measurement Circuit**

The “Auto Test” mode automatically tests the Measurement Circuits. In the “Manual Test” mode, you can enter a voltage signal for the Bridge Voltage, or a pressure rating to simulate system pressure.

1. Press the UP or DOWN button to select “Auto Test” or “Manual Test” and press the ENTER button.
2. In the “Auto Test” mode, press the ENTER button to allow the 475 Controller to perform the diagnostics check.
3. In the “Manual Test” mode, use the UP or DOWN button to select either Bridge Voltage or “Pressure” and press the Enter button.
4. Press the UP or Down button to enter the desired voltage in the “Bridge Voltage” mode, or the desired pressure in the “Pressure” mode.

- **Test Analog Output**

The “Auto Test” mode automatically tests the Analog Output Circuits. In the “Manual Test” mode, you can enter a voltage to apply to the Analog Output to simulate system pressure or for system setup.

1. Press the UP or DOWN button to select “Auto Test” or “Manual Test” and press the ENTER button.
2. In the “Auto Test” mode, press the ENTER button to allow the 475 Controller to perform the diagnostics check.
3. In the “Manual Test” mode, press the UP or Down button to enter the desired voltage to be output.
4. Press ENTER to perform the diagnostics check.

#### **3.4.4 Calibrate**

When the Calibrate function is selected, the 475 Controller reads the current pressure in the vacuum chamber and determines whether you can calibrate at atmosphere or vacuum based on the current pressure.

See *Calibration* and *NIST Traceable System Calibration* on page 49 for more detailed information.

1. Press the UP or DOWN button to scroll to “Calibrate” and press the ENTER button.

Either “Calibrate Vacuum” or “Calibrate Atmosphere” will be shown depending on the current reported pressure.

*NOTE: “Invalid Pressure for Cal” will be displayed if the pressure is out of range to perform the calibration.*

- **Calibrate Atmosphere**

1. Press the UP or DOWN button to select the desired calibration setting and press the ENTER button.
2. Press the BACK button a few times or wait one minute to return to

pressure display.

- **Calibrate Vacuum**

1. Press the UP or DOWN button to select the desired calibration setting and press the ENTER button.
2. Press the BACK button a few times or wait one minute to return to pressure display.

### 3.5 Configure

The Configure menu item allows the user to view, select, and set the control functions of the 475 Controller. See Figure 3-2.

#### 3.5.1 Setpoint Parameters

Two process control setpoints provide control of other vacuum system equipment such as valves, pumps, heaters, alarms, and safety interlocking.

1. Press the UP or DOWN button to scroll to “Configure” and press the ENTER button.
2. Press the UP or DOWN button to select “Setpoint 1” or “Setpoint 2” and press the ENTER button.
3. Press the UP or DOWN button to select “Value”, “Hysteresis”, “Polarity”, or “Relay” and press the ENTER button.

##### **Value**

1. The indicated setting will show in reverse video. Press the UP or DOWN button to select the desired setpoint.
2. Press the ENTER button to save the selection.
3. Press the BACK button a few times or wait one minute to return to pressure display.

##### **Hysteresis**

1. The indicated setting will show in reverse video. Press the UP or DOWN button to select the desired “Hysteresis” percentage.
2. Press the ENTER button to save the selection.
3. Press the BACK button a few times or wait one minute to return to pressure display.

##### **Polarity**

1. The indicated setpoint polarity setting will show in reverse video. Press the UP or DOWN button to select “Normal” or “Reverse”.
2. Press the ENTER button to save the selection.
3. Press the BACK button a few times or wait one minute to return to pressure display.

##### **Relay**

1. The indicated setpoint relay setting will show in reverse video. Press the UP or DOWN button to select “Enabled” or “Disabled”.
2. Press the ENTER button to save the selection.
3. Press the BACK button a few times or wait one minute to return to pressure display.

### 3.5.2 RS-232 Parameters

The RS-232 interface permits data output to, and Convectron gauge control by, a host computer. Output control is either by a command-response mechanism or a hardwire control line between RTS and CTS. A variety of baud rates and byte framing options are available. See *Chapter 5* for detailed information regarding the RS-232 parameters.

1. Press the UP or DOWN button to scroll to “Configure” and press the ENTER button.
2. Press the UP or DOWN button to select “RS-232 Parameters” and press the ENTER button.
3. Press the UP or DOWN button to select “Baud Rate”, “Data Format”, or “Handshake” and press the ENTER button.

#### **Baud Rate**

1. The indicated setting will show in reverse video. Use the UP and DOWN buttons to scroll to the desired Baud Rate setting.
2. Press the ENTER button to save the selection.
3. Press the BACK button a few times or wait one minute to return to pressure display.

#### **Data Format**

1. The indicated setting will show in reverse video. Use the UP and DOWN buttons to scroll to the desired Data Format setting.
2. Press the ENTER button to save the selection.
3. Press the BACK button a few times or wait one minute to return to pressure display.

#### **Handshake**

1. The indicated setting will show in reverse video. Use the UP and DOWN buttons to select “Enable” or “Disable”.
2. Press the ENTER button to save the selection.
3. Press the BACK button a few times or wait one minute to return to pressure display.

See *RS-232 Handshake* on page 58 for more detailed information on the Handshake function.

### 3.5.3 Analog Output

The Analog Output produces a DC voltage at the output with a range of at least 0 to 10.5 Vdc.

You can request a voltage value on the Analog Output so you can calibrate/verify a system. (The Controller must be in the Diagnostic menu.) You can also apply an offset to the Analog Output.

See *Convectron Gauge Analog Output Signal* on page 50 for more detailed information.

1. Press the UP or DOWN button to select “Configure” and press the ENTER button.
2. Press the UP or DOWN button to select “Analog Output” and press the ENTER button.
3. Press the UP or DOWN button to select “Analog Format” or “Analog Offset” and press the ENTER button.

**Analog Format**

1. The indicated setting will show in reverse video. Press the UP or DOWN button to select the desired Analog Format voltage range.
2. Press the ENTER button to save the selection.
3. Press the BACK button a few times or wait one minute to return to pressure display.

**Analog Offset**

1. The indicated setting will show in reverse video. Press the UP or DOWN button to select the desired Analog voltage offset.
2. Press the ENTER button to save the selection.
3. Press the BACK button a few times or wait one minute to return to pressure display.

**3.5.4 Pressure Units**

The selected pressure unit of measure will be displayed for measured pressure and setpoint pressure values.

1. Press the UP or DOWN button to select "Configure" and press the ENTER button.
2. Press the UP or DOWN button to select "Pressure Units" and press the ENTER button.
3. The indicated unit will show in reverse video. Press the UP or DOWN button to select Torr, mbar, or Pa.
4. Press the ENTER button to save the unit selection.
5. Press the BACK button a few times or wait one minute to return to pressure display.

**3.5.5 Display Options**

The Display Options menu allows you to select the displayed pressure format, setpoints, and the brightness of the display screen.

**Pressure Format**

The Display Format affects pressure notation, which can be set to scientific notation or Torr/mTorr notation (units dependent).

- Scientific notation provides a consistent display width.
  - Torr/mTorr format is similar to that of the Series 375 Controller.
1. Press the UP or DOWN button to select "Configure" and press the ENTER button,
  2. Press the UP or DOWN button to select "Display Options" and press the ENTER button.
  3. Press the UP or DOWN button to select "Pressure Format" and press the ENTER button.
  4. Press the UP or DOWN button to select "Torr/mTorr" or "Scientific" and press the ENTER button to save the selected format.
  5. Press the BACK button a few times or wait one minute to return to the pressure display.

**Show Setpoints**

The pressure display may be set so it shows pressure only or shows pressure and setpoint status. When pressure only is selected, the font is larger and can be seen from a greater distance. When setpoint status is shown, status and pressure will be shown. Setpoint status is indicated by a rectangle icon that will be filled if the relay is energized or open if the relay is not energized. See Figure 3-3.

1. Press the UP or DOWN button to select “Configure” and press the ENTER button.
2. Press the UP or DOWN button to select “Display Options” and press the ENTER button.
3. Press the UP or DOWN button to select “Show Setpoints” and press the ENTER button.
4. Press the UP or DOWN button to change the setpoint display status to “Yes” or “No”.
5. Press the ENTER button to save the show setpoints parameter.
6. Press the BACK button a few times or wait one minute to return to pressure display.

**Figure 3-3 Setpoint Indicators**

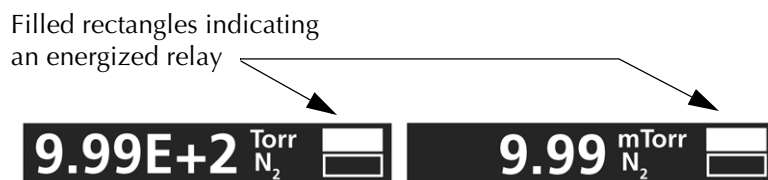
**Brightness**

The display brightness (1, 2, or 3) can be adjusted to a preferred level. Setting the display to a lower brightness will extend the life of the display. The factory default setting is 3.

1. Press the UP or DOWN button to select “Configure” and press the ENTER button.
2. Press the UP or DOWN button to select “Display Options” and press the ENTER button.
3. Press the UP or DOWN button to select “Brightness” and press the ENTER button.
4. Press the UP or DOWN button to change the brightness of the display.
5. Press the ENTER button to save the display brightness setting.
6. Press the BACK button a few times or wait one minute to return to pressure display.

**3.5.6 Gas Species**

The selected gas species will be displayed and can be changed to another type of gas.

The controller is calibrated for N<sub>2</sub> unless otherwise displayed on the front panel for custom applications. When a gas other than N<sub>2</sub> is selected, the *Indicated vs. True Pressure* charts listed in *Indicated vs. True Pressure for Gases Other Than N<sub>2</sub> or Air* beginning on page 39 are not required.

The 475 controller uses a lookup table of bridge voltages and pressures to convert the voltage given from the A/D to a pressure. Lookup tables exist for N<sub>2</sub> (default), Ar, He, CO<sub>2</sub>, and O<sub>2</sub>. A Factory-Specified (FS) lookup table may also exist.

In addition, a Correction Factor (CF) can be applied when a gas other than N<sub>2</sub> is a constant multiplication factor (rather than a curve) of N<sub>2</sub>. See the graphs in *Indicated vs. True Pressure for Gases Other Than N<sub>2</sub> or Air* on page 39. This is only accurate at low pressures and has a range of 0.1 to 1.5 in increments of 0.1. The CF gas setting can be selected and programmed by using the Menu buttons on the front of the controller. See *Correction Factor Parameters* on page 35.

At the time the gas species is changed, a pressure high-limit is changed so that a warning is given of possible over-pressure conditions. If a correction factor is entered, you can enter an upper limit.

An example process:

- Switch gas species from N<sub>2</sub> to Ar.
  - Pressure conversion switches to the Ar curve.
  - The over-pressure error limit is changed to reflect Ar.
1. Press the UP or DOWN button to select "Configure" and press the ENTER button.
  2. Press the UP or DOWN button to select "Gas Species" and press the ENTER button.
  3. The indicated unit will show in reverse video. Press the UP or DOWN button to select N<sub>2</sub>, Ar, CF (Correction Factor), or FS (Factory Specification).
  4. Press the ENTER button to save the gas species selection.
  5. Press the BACK button a few times or wait one minute to return to pressure display.

### 3.5.7 Pressure Filtering

Pressure Filtering allows additional filtering of the pressure reading. You can set the delay time in milliseconds for the 475 Controller to display a pressure reading, and Enable or Disable the Low-Pass Filter. "Response Delay" provides a delayed readout of the indicated pressure.

1. Press the UP or DOWN button to select "Configure" and press the ENTER button.
2. Press the UP or DOWN button to select "Pressure Filtering" and press the ENTER button.
3. Press the UP or DOWN button to select "Response Delay" or "LPF" (Low-Pass Filter).
4. Press the ENTER button to open the selection.

#### **Response Delay**

1. The indicated unit will show in reverse video. Press the UP or DOWN button to select the desired delay time.
2. Press the ENTER button to save the time selection.
3. Press the BACK button a few times or wait one minute to return to pressure display.

### ***LPF (Low-Pass Filter)***

1. The indicated unit will show in reverse video. Press the UP or DOWN button to select Enable or Disable.
2. Press the ENTER button to save the selection.
3. Press the BACK button a few times or wait one minute to return to pressure display.

### **3.5.8 Restore Configuration**

“Restore Configuration” allows the user to switch to any of the four saved configurations. Four different configurations (one factory default and three user-set configurations) can be programmed and saved. Each user setting will include unique setpoint parameters, unit of measure, analog output setting, computer interface parameters, atmosphere and vacuum calibrations, gas species setting, and display options. Initial user settings are programmed to the factory defaults.

1. Press the UP or DOWN button to select “Configure” and press the ENTER button.
2. Press the UP or DOWN button to select “Restore Config.” and press the ENTER button.
3. The indicated unit will show in reverse video. Press the UP or DOWN button to select 1, 2, 3, or Defaults.
4. Press the ENTER button to save the selection.
5. Press the BACK button a few times or wait one minute to return to pressure display.

### **3.5.9 Save Configuration**

“Save Configuration” allows the user to save up to three configurations in addition to the factory default configuration. Three different user settings can be programmed and saved. Each user setting will include unique setpoint parameters, unit of measure, analog output setting, computer interface parameters, atmosphere and vacuum calibrations, gas species setting, and display options.

1. Press the UP or DOWN button to select “Configure” and press the ENTER button.
2. Press the UP or DOWN button to select “Save Config.” and press the ENTER button.
3. The indicated unit will show in reverse video. Press the UP or DOWN button to select 1, 2, or 3.
4. Press the ENTER button to save the selection.
5. Press the BACK button a few times or wait one minute to return to pressure display.

### **3.5.10 Gauge Sensor Type**

“Sensor Type” allows the user to set the type of sensor in the Convector gauge. The most common type of sensor used in the Convector gauge is Gold-plated Tungsten. However, a Platinum sensor is used for some applications where chemically corrosive gases such as chlorine, fluorine, or mercury vapor are used. Check the list of Convector gauge catalog numbers on page 4 of this manual to determine which type of sensor is in the Convector gauge on your system.

1. Press the UP or DOWN button to select “Configure” and press the ENTER button.

2. Press the UP or DOWN button to select “Gauge Sensor Type” and press the ENTER button.
3. The indicated unit will show in reverse video. Press the UP or DOWN button to select Gold-Tungsten or Platinum.
4. Press the ENTER button to save the selection.
5. Press the BACK button a few times or wait one minute to return to pressure display.

### **3.5.11 Correction Factor Parameters**

The Correction Factor is a scaling of a pressure reading to a new reading. The Correction Factor (CF) can be applied when a gas other than N<sub>2</sub> is a constant multiplication factor (rather than a curve) of N<sub>2</sub>. See the graphs in *Indicated vs. True Pressure for Gases Other Than N<sub>2</sub> or Air* on page 39. This is only accurate at low pressures and has a range of 0.1 to 1.5 in increments of 0.1.

1. Press the UP or DOWN button to select “Configure” and press the ENTER button.
2. Press the UP or DOWN button to select “Gas Species” and press the ENTER button.
3. Press the UP or DOWN button to select “Correction Factor” and press the ENTER button.
4. Press the ENTER button again to highlight the current CF setting.
5. Press the UP or DOWN button to select the desired Correction Factor (0.1 to 1.5) and press the ENTER button to save the new CF setting.
6. Press the BACK button a few times or wait one minute to return to pressure display.

#### ***Correction Factors***

The Correction Factor is a scaling of a pressure reading to a new reading.

1. Press the UP or DOWN button to select “CF”.
2. Press the ENTER button to open the “Correction Factors”. Press the ENTER button to display the current Correction Factor.
3. Press the UP or DOWN button to select the desired Correction Factor multiplier (0.1 to 1.5) and press the ENTER button to save the new setting.

#### ***Maximum Pressure***

When a gas species is changed, a pressure high-limit must be entered so a warning is given of possible over-pressure conditions. If a correction factor is entered, you can enter an upper limit.

1. Press the UP or DOWN button to select “Max Pressure”.
2. Press the ENTER button to open the “Max Pressure”. Press the ENTER button to display the current Maximum Pressure setting.
3. Press the UP or DOWN button to select the desired Maximum Pressure Setting (1 mTorr to 999 Torr) and press the ENTER button to save the new setting.

### 3.6 Error Codes

A known error produces an error code that is displayed to the user. More than one error results in a rotation of errors on the display. An error is also reported to the user through digital communications.

When there are errors, the pressure readout is readjusted to a smaller font.

**Table 3-1 Series 475 Controller Error Codes**

Error Code	Comm Error Code for "RD"	Error	Comments
ERR 01 CGBAD	OPN SNSR	The Convectron gauge is either unplugged or defective	Reported pressure is 999T, relays off
ERR 09 NVRAM		Not able to retrieve information from EEPROM	
ERR 14 CABLE	SNSR UNP	The cable is either unplugged or defective	Reported pressure is 999T, relays off
ERR 15 ADBAD		The A/D Converter is reporting an erroneous value	Reported pressure is 999T, relays off
ERR 16 AOBAD		The Analog Output is reporting an erroneous value	
ERR 17 OVPRS	SNSR OVP	The maximum pressure limit has been reached	Reported pressure is max reported pressure for gas species (999 Torr for N <sub>2</sub> )
ERR 18 FAC		CRC-16 checksum verification of factory settings failed	Revert to the hardcoded values
ERR 19 FS		CRC-16 checksum verification of "FS" curve failed	Revert to the N <sub>2</sub> curve

### 3.7 Preparing For Convectron Gauge Operation

Convectron gauge pressure is indicated on the Controller front panel display. Install pressure limiting devices calibrated to a level that the vacuum system can safely withstand. In addition, install pressure relief valves or rupture disks that will release pressure at a level considerably below the maximum safe pressure level of the system. Confirm that these safety devices are properly installed before installing the controller.

In addition, make sure:

- The proper gas cylinders are installed,
- Gas cylinder valve positions are correct on manual systems, and
- The automation settings are correct on automated gas delivery systems.

Vacuum gauges with compression fittings may be forcefully ejected if the vacuum system is pressurized.

### 3.8 Convectron Gauge Theory of Operation

The Convectron gauge transducer is represented in Figure 3-4 as R1, R2, R3, and R4. These four resistances form the legs of a bridge circuit, with R1 designating the sensor wire of the transducer. R2 is a resistive network in the gauge tube that compensates for changes in the ambient temperature. At bridge null,  $R1 = R2 \times R3 / R4$ . If there are no changes in ambient temperature, the value of R1 is a constant and the bridge is balanced.

Figure 3-4 Convectron Gauge Schematic

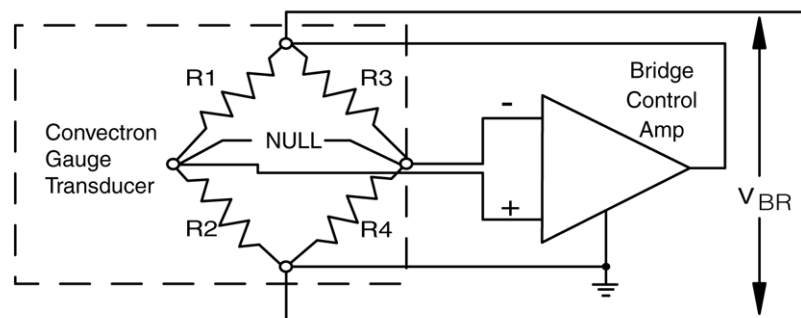

The Convectron gauge operates like a standard Pirani gauge, which employs the principle of a Wheatstone bridge to convert pressure to voltage, but uses convection cooling to enable accurate pressure measurement, when properly calibrated, from  $10^{-4}$  to 1000 Torr. The sensing wire is an ultra-fine strand of gold-plated tungsten or solid platinum.

As the vacuum system pressure is decreased, there are fewer molecules in the system to conduct the heat away from the sensor wire causing the temperature and resistance of R1 to increase. The increased resistance of R1 causes the bridge to unbalance and a voltage is developed across the null terminals. The bridge control circuit senses the null voltage and decreases the voltage across the bridge until the null voltage is again zero. When the bridge voltage is decreased, the power dissipated in the sensor wire is decreased causing the resistance of R1 to decrease to its previous value. The opposite events happen for a pressure increase. The bridge voltage is a nonlinear function of pressure.

**3.9 Convectron Gauge Sensors****Using Sensors other than Gold-Plated Tungsten**

Another factor that affects the bridge voltage vs. pressure relationship is the type of sensor wire used in the 275 Convectron gauge, which is either a gold-plated tungsten (common) or a platinum sensor wire. The platinum sensor is used only in some applications that are corrosive to the gold-plated tungsten sensor.

Like the gas species, the 475 is also able to change the bridge voltage vs. pressure relationship for different sensor types. And, like the gas species, the 475 also has different user calibrations for each sensor type. Switching the sensor type also switches the user calibration. See *Gauge Sensor Type* on page 34 to change the setting in the Controller.

**3.10 Using Gases Other than N<sub>2</sub> or Air**

The 475 Convectron Gauge Controller calculates pressure by:

- balancing the Convectron bridge,
- measuring the bridge voltage,
- applying any "user calibration" settings, and
- looking up the corresponding pressure in a bridge voltage vs. pressure table.

Among other factors, the bridge voltage vs. pressure relationship is dependent on the gas species in the system. The gas species, and therefore the bridge voltage vs. pressure relationship, can be changed through the front panel of the Controller or through the RS-232 interface.

See *Gas Species* on page 32 to select and use correction parameters when using Ar, He, CO<sub>2</sub>, or O<sub>2</sub>.

**3.10.1 Effects on User Calibration**

The 475 Controller has a different user calibration for each gas species (Ar, He, CO<sub>2</sub>, or O<sub>2</sub>) except "CF" (which uses N<sub>2</sub> calibration) and "FS" (where the calibration is built into the lookup-table). Switching the gas species automatically switches the user calibration. Resetting the calibration to factory defaults only affects the gas species currently in use.

Calibrating for each gas species provides more accurate pressure readings.

***Correction Factor (CF)***

The correction factor (CF function) can be used at low pressures on the Convectron gauge when most gases are proportional to N<sub>2</sub> and the proportion is known. The controller uses the N<sub>2</sub> bridge voltage vs. pressure relationship (and user calibration) and multiplies it by the correction factor -

$$(P_{new}) = (P_{N_2})(CF)$$

***Factory Specified (FS)***

The factory specified function can be used when the factory, at the request of the customer, has loaded a bridge voltage vs. pressure relationship that is specific to the controller - cable - gauge combination. Contact Brooks Automation for more details.

### 3.10.2 Indicated vs. True Pressure for Gases Other Than N<sub>2</sub> or Air

**NOTE:** Use the information in this section only if you are NOT using the Calibrated Gas Species function of the 475 Controller. The 475 Controller uses lookup tables of bridge voltages and pressures to convert the voltage given from the Analog-to-Digital converter (A/D) to a pressure reading. Factory-programmed lookup tables exist for N<sub>2</sub> (default), Ar, He, CO<sub>2</sub>, and O<sub>2</sub>.

#### **WARNING**

**If accurate conversion data is not used, or is improperly used, a potential overpressure explosion hazard can be created under certain conditions. Using the N<sub>2</sub> calibration to pressurize a vacuum system above about 1 Torr with certain other gases can cause dangerously high pressures which may cause explosion of the system.**

Convectron Gauges are Pirani type thermal conductivity gauges. These gauges measure the heat loss from a heated sensor wire maintained at constant temperature. The controller converts this measurement into gas pressure readings. For gases other than nitrogen or air the heat loss varies at any given true pressure and can result in inaccurate pressure readings.

It is important to understand that the pressure indicated by a Convectron gauge depends on the type of gas, the orientation of the gauge axis, and the gas density in the gauge. Convectron gauges are normally factory calibrated for N<sub>2</sub> (air has approximately the same calibration). With proper precautions, the Convectron gauge may be used for pressure measurement of certain other gases.

At pressures below a few Torr, there is no danger in measuring pressure of gases other than N<sub>2</sub> and air, merely inaccurate readings. A danger arises if the N<sub>2</sub> calibration is used without correction to measure higher pressure levels of some other gases. For example, N<sub>2</sub> at 24 Torr causes the same heat loss from the Convectron sensor as argon will at atmospheric pressure. If the pressure indication of the Convectron gauge is not properly corrected for argon, an operator attempting to fill a vacuum system with 1/2 atmosphere of argon would observe a pressure reading of only 12 Torr when the actual pressure had risen to the desired 380 Torr. Continuing to fill the system with argon to 760 Torr would result in a 24 Torr pressure reading.

Depending on the pressure of the argon gas source, the chamber could be dangerously pressurized while the display continued to read about 30 Torr of N<sub>2</sub> equivalent pressure. This type of danger is not unique to the Convectron gauge and likely exists with other thermal conductivity gauges using convection to extend the range to high pressures.

To measure the pressure of gases other than air, or N<sub>2</sub> with a Convectron gauge calibrated for N<sub>2</sub>, you must use the conversion curves listed specifically for Convectron gauges to translate between indicated N<sub>2</sub> pressure and true pressure, or use the correct gas species setting. The gas species settings can be selected by using the Menu buttons on the front of the controller. *Do not use other data. Never use the conversion curves designed for Convectron gauges to translate pressure readings for gauges made by other manufacturers.* Their geometry is very likely different and dangerously high pressures may be produced even at relatively low pressure indications.

You must ensure that the atmosphere adjustments for the Convector gauge are correctly set. (See *Atmosphere Calibration* on page 48.)

Figure 3-5 through Figure 3-10 show the true pressure vs. indicated pressure for 11 commonly used gases. Table 3-2 will help to locate the proper graph.

**Table 3-2 Pressure vs. Indicated N<sub>2</sub> Pressure Curve**

Figure Number	Pressure Range and Units	Gases
Figure 3-5	10 <sup>-4</sup> to 10 <sup>-1</sup> Torr	All
Figure 3-6	10 <sup>-1</sup> to 1000 Torr	Ar, CO <sub>2</sub> , CH <sub>4</sub> , Freon 12, He
Figure 3-7	10 <sup>-1</sup> to 1000 Torr	D <sub>2</sub> , Freon 22, Kr, Ne, O <sub>2</sub>
Figure 3-8	10 <sup>-4</sup> to 10 <sup>-1</sup> mbar	All
Figure 3-9	10 <sup>-1</sup> to 1000 mbar	Ar, CO <sub>2</sub> , CH <sub>4</sub> , Freon 12, He
Figure 3-10	10 <sup>-1</sup> to 1000 mbar	D <sub>2</sub> , Freon 22, Kr, He, O <sub>2</sub>

Note that 1 mbar = 100 Pa, so the mbar charts may be used for Pascal units by multiplying the values on the axes by 100.

A useful interpretation of these curves is, for example, that at a true pressure of  $2 \times 10^{-2}$  Torr for CH<sub>4</sub> the heat loss from the sensor is the same as at a true pressure of  $3 \times 10^{-2}$  for N<sub>2</sub> (see Figure 3-5). The curves at higher pressure vary widely from gas to gas because thermal losses at higher pressures are greatly different for different gases.

If you must measure the pressure of gases other than N<sub>2</sub> or air use Figure 3-5 through Figure 3-10 to determine the maximum safe indicated pressure for the other gas as explained in the examples that follow.

### 3.10.3 Examples

#### **Example 1: Maximum safe indicated pressure**

Assume a given vacuum system will withstand an internal pressure of 2000 Torr or 38.7 psia. For safety, you want to limit the maximum internal pressure to 760 Torr during the backfilling process. Assume you want to measure the pressure of Freon 22. On Figure 3-6, locate 760 Torr on the left hand scale, travel to the right to the intersection with the Freon 22 curve, then down to an indicated pressure of 11 Torr (N<sub>2</sub> equivalent). In this hypothetical situation, the maximum safe indicated pressure for Freon 22 is 11 Torr.

For the sake of safety, it is prudent to place a warning label on the instrument face stating "DO NOT EXCEED 11 TORR FOR FREON 22" for this example.

#### **Example 2: Indicated to true pressure conversion**

Assume you want to determine the true pressure of helium in a system when the Convector is indicating 10 Torr. On Figure 3-6, follow the vertical graph line up from the 10 Torr (N<sub>2</sub> equivalent) indicated pressure to the Helium curve, then move horizontally to the left to reveal a true pressure of 4.5 Torr. Thus 4.5 Torr Helium pressure produces an indication of 10 Torr (N<sub>2</sub> equivalent).

**Example 3: True to indicated pressure conversion**

Assume you want to set a process control setpoint at a true pressure of 20 Torr of CO<sub>2</sub>. On Figure 3-6, locate 20 Torr on the true pressure scale, travel horizontally to the right to the CO<sub>2</sub> curve, then down to an indicated pressure of 6.4 Torr (N<sub>2</sub> equivalent). The correct process control setting for 20 Torr of CO<sub>2</sub> is 6.4 Torr (N<sub>2</sub> equivalent).

**Example 4: True to indicated pressure conversion**

Assume you want to obtain a helium pressure of 100 Torr in the system. On Figure 3-6, locate 100 Torr on the left hand scale, travel horizontally to the right to attempt to intersect the He curve. Because the intersection is off scale, it is apparent that this true pressure measurement requirement for helium exceeds the capability of the instrument.

For gases other than those listed, the user must provide accurate conversion data for safe operation. The Convectron gauge is not intended for use above approximately 1000 Torr true pressure.

Figure 3-5 Convectron Gauge Indicated vs. True Pressure Curve;  $10^{-4}$  to  $10^{-1}$  Torr

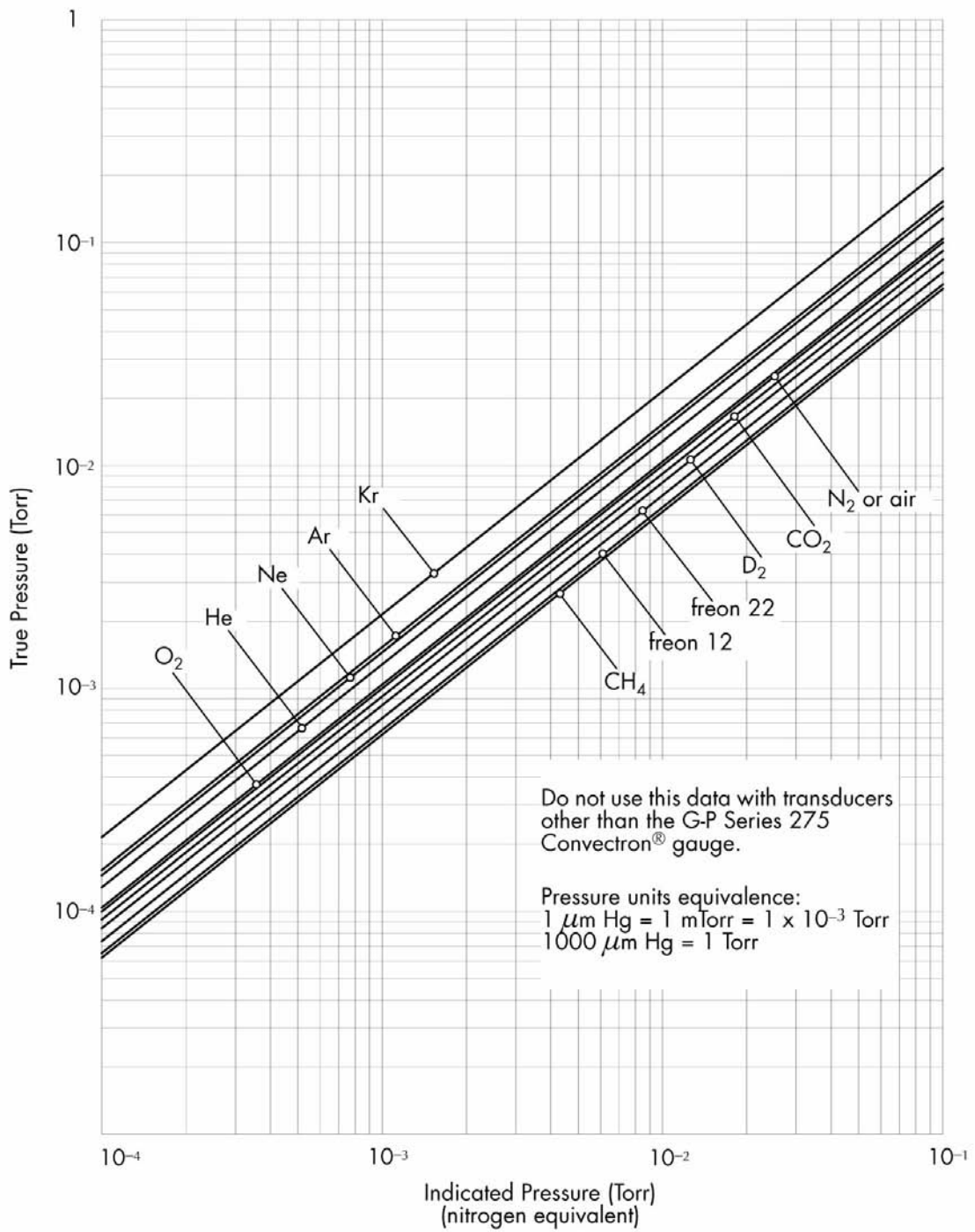

Figure 3-6 Convectron Gauge Indicated vs. True Pressure Curve; .01 to 1000 Torr

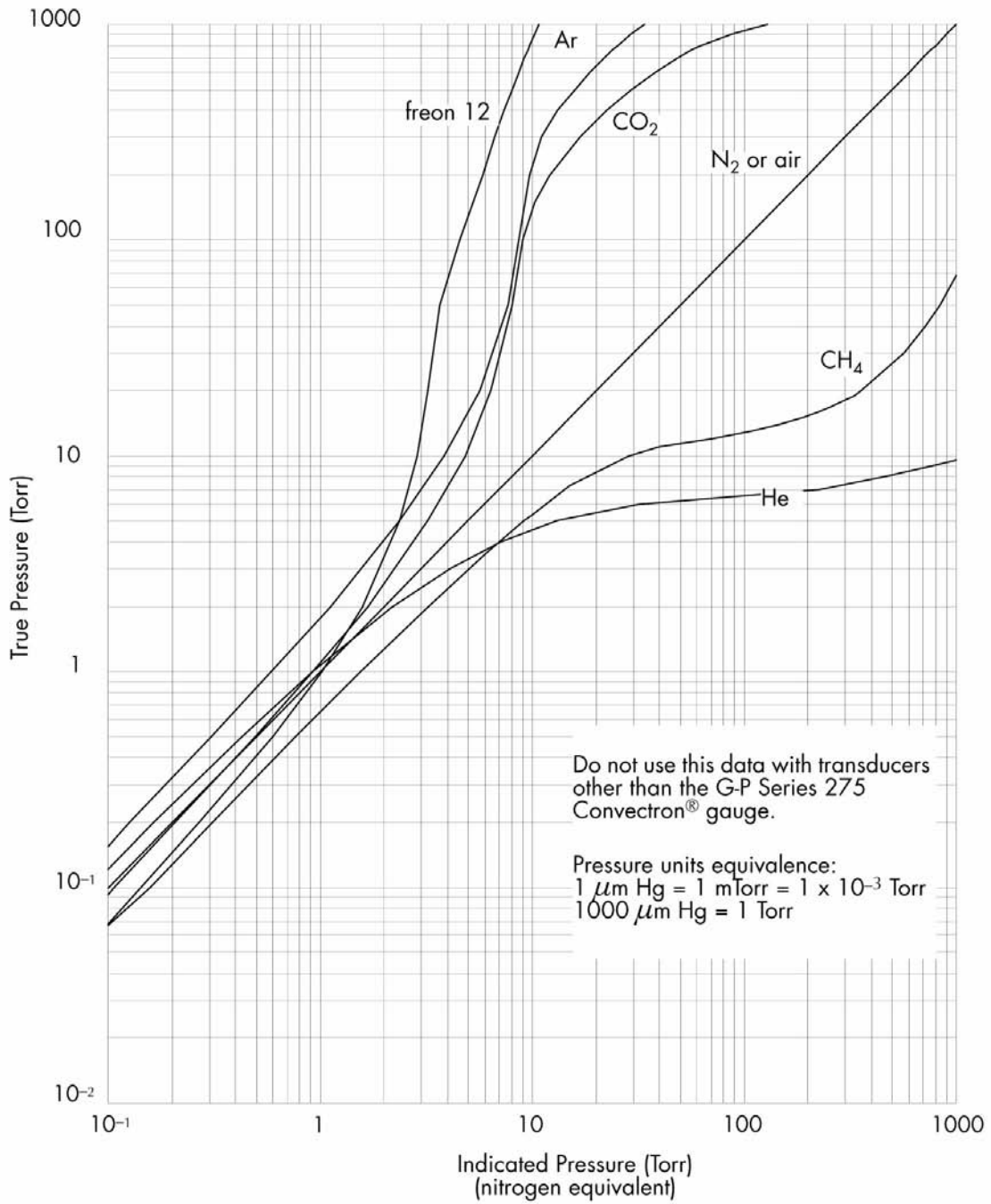

Figure 3-7 Convectron Gauge Indicated vs. True Pressure Curve; .01 to 1000 Torr

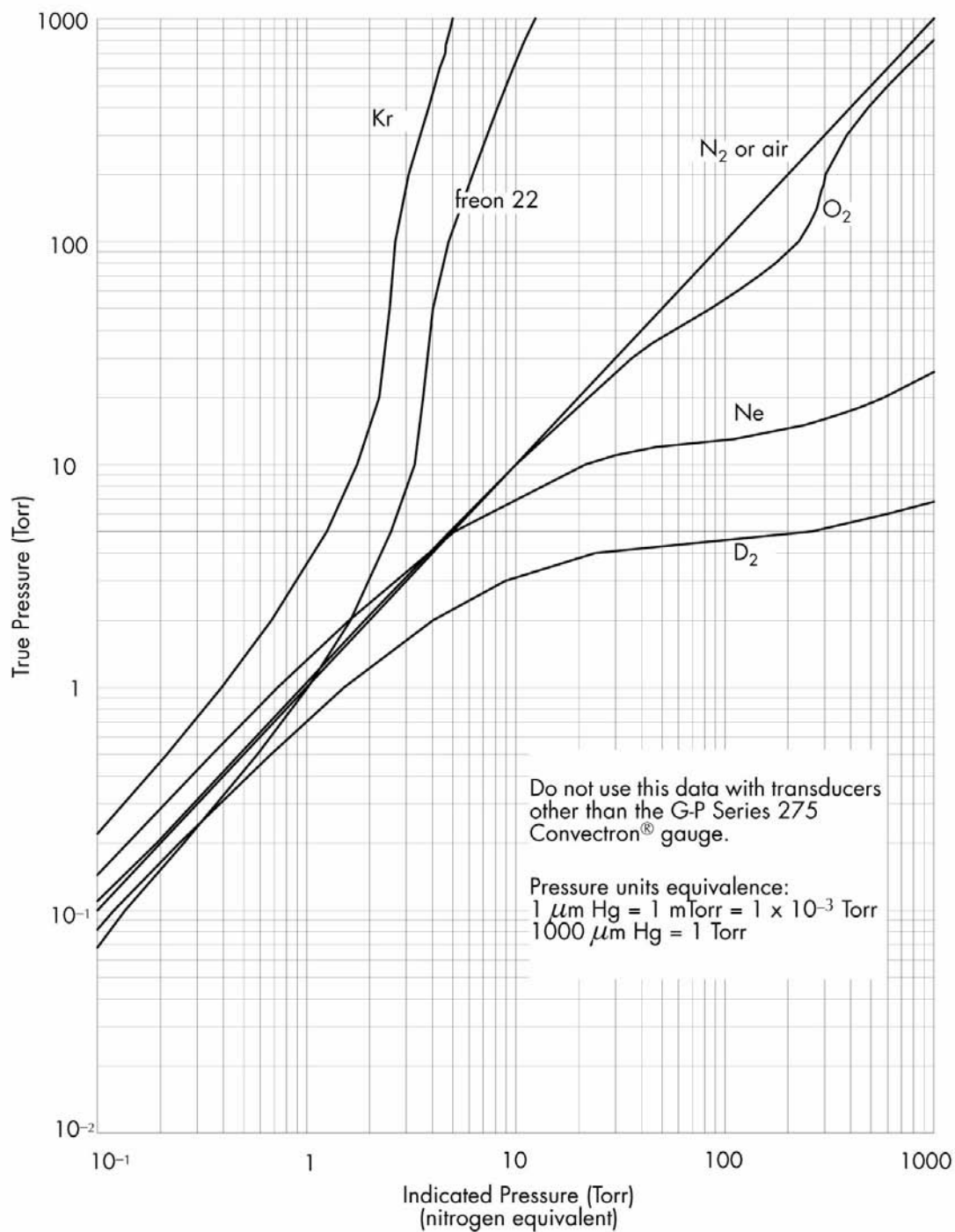

Figure 3-8 Convectron Gauge Indicated vs. True Pressure Curve;  $10^{-4}$  to  $10^{-1}$  mbar

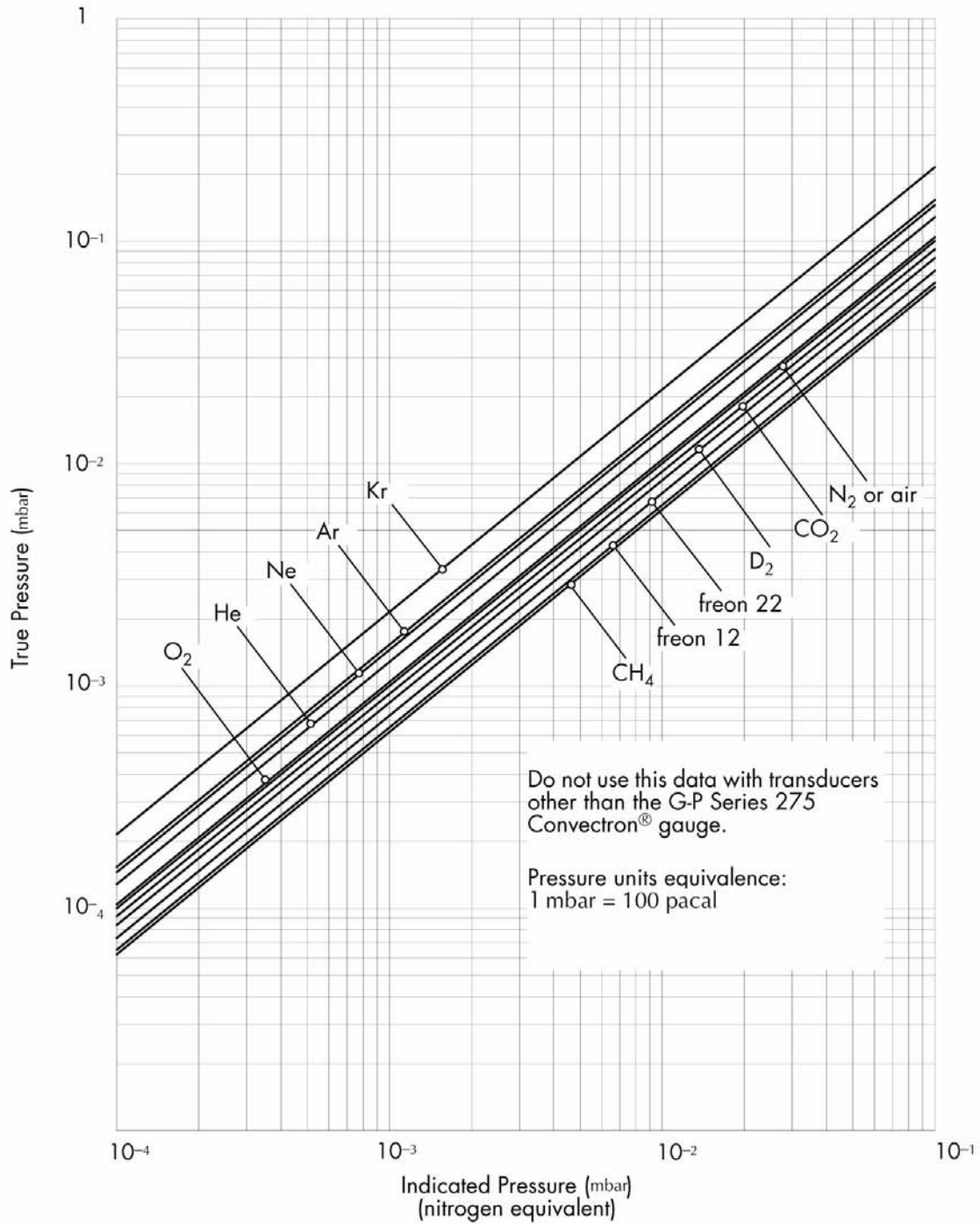

Figure 3-9 Convectron Gauge Indicated vs. True Pressure Curve; .01 to 1000 mbar

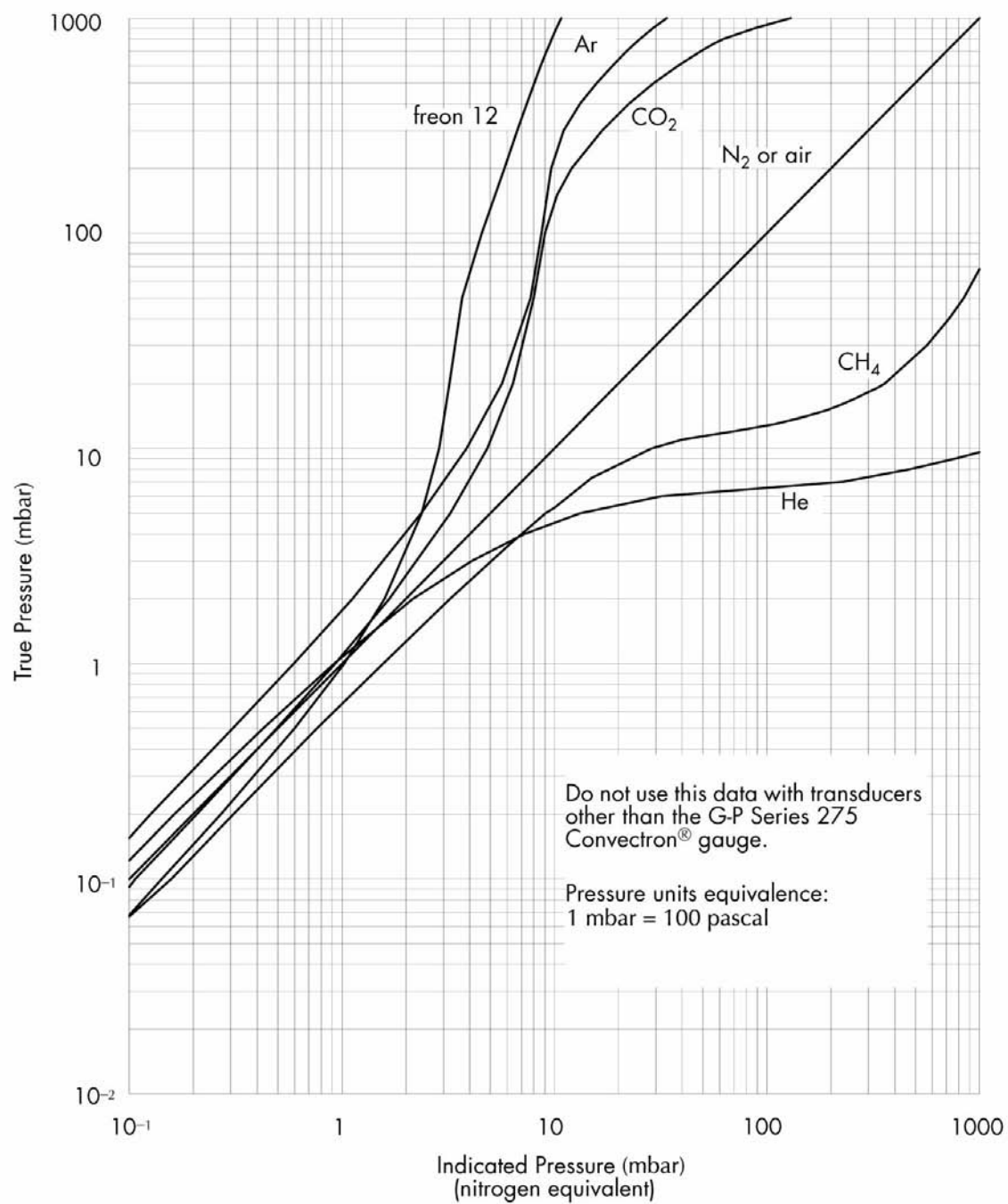
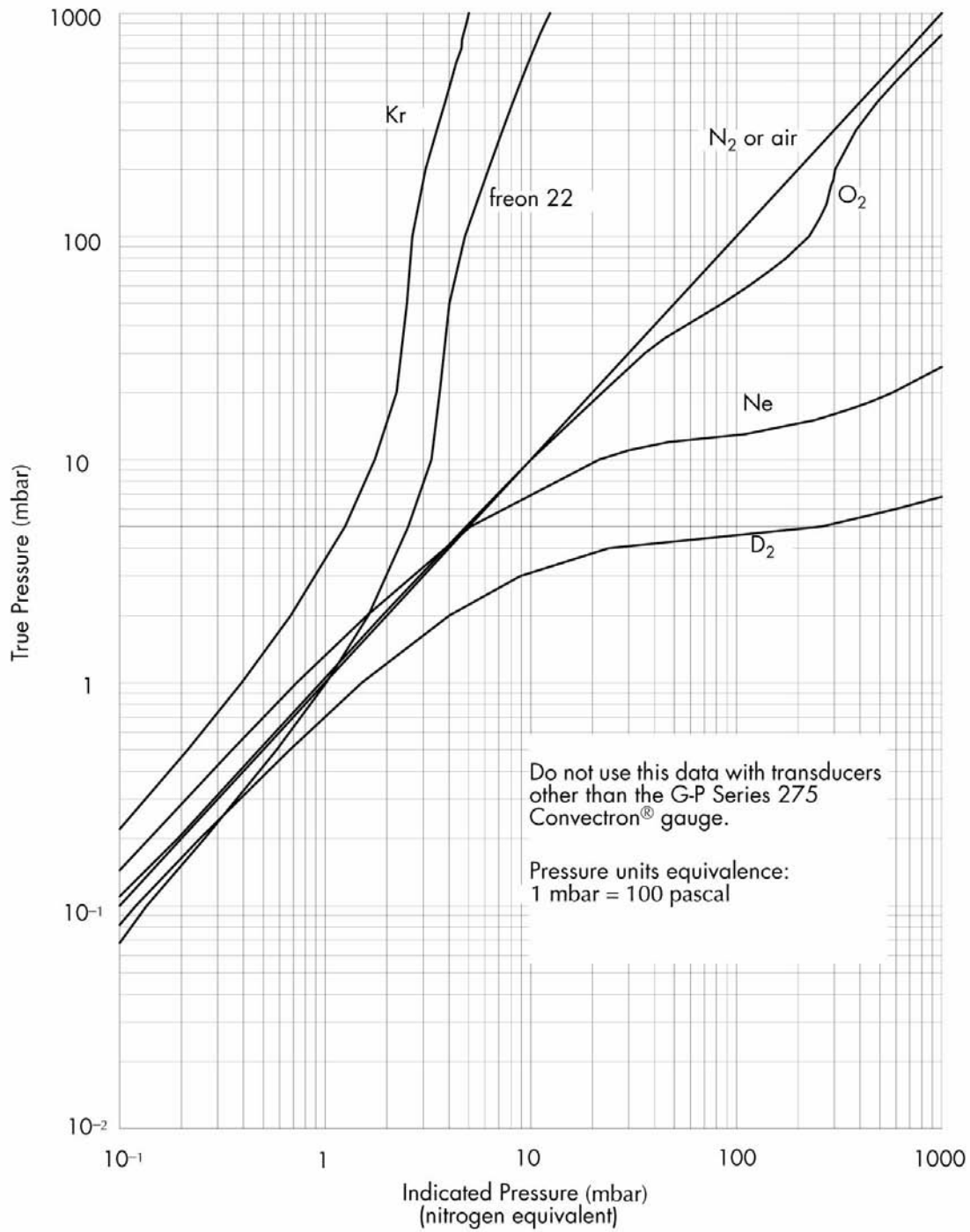

Figure 3-10 Convectron Gauge Indicated vs. True Pressure Curve; .01 to 1000 mbar



### 3.11 Calibration

Each Convector gauge is individually calibrated for N<sub>2</sub>. “Zero” adjustment of the gauge should not be necessary unless readout accuracy is required below  $1 \times 10^{-3}$  Torr or the gauge has been contaminated. Adjustment of the atmospheric indication should not be necessary unless compensating for long cables, variations in mounting orientation, or contamination.

The Convector gauge has a stable, temperature compensated design. Each controller is also calibrated to provide accurate readout of N<sub>2</sub> pressure with any Convector gauge when the gauge is properly installed with the gauge axis horizontal.

#### 3.11.1 Calibration Ranges for Different Gas Species

Calibration is possible only within certain pressure ranges. The ranges are gas specific as listed below.

**Table 3-3 Calibration Limits**

Gas Species	Sensor Type	Calibration Limit at Atmosphere (Torr)	Calibration Limit at Vacuum (Torr)
Nitrogen (N <sub>2</sub> )	Gold-Tungsten or Platinum	400 to 999	0 to 0.1
Argon (Ar)	Gold-Tungsten or Platinum	400 to 999	0 to 0.1
Helium (He)	Gold-Tungsten	1 to 8	0 to 0.1
Helium (He)	Platinum	1 to 6	0 to 0.1
Carbon Dioxide (CO <sub>2</sub> )	Gold-Tungsten or Platinum	400 to 999	0 to 0.1
Oxygen (O <sub>2</sub> )	Gold-Tungsten or Platinum	400 to 999	0 to 0.1

#### 3.11.2 Vacuum Calibration

Evacuate the Convector gauge to a pressure less than 100 mTorr. If the calibration is for 0.0, evacuate to less than  $1 \times 10^{-5}$  Torr and allow system to stabilize for 15 minutes,

1. Press the UP or DOWN button until “Calibrate” is displayed and press the ENTER button. “Calibrate VAC 0.0” is displayed.
2. If “Invalid Pressure for CAL” or “Invalid Function NIST CAL” is displayed, calibration will not be possible.
3. Press the ENTER button to calibrate at vacuum or press the UP or DOWN button to calibrate at any pressure between 0.0 and 100 mTorr, then press the ENTER button to calibrate.

#### 3.11.3 Atmosphere Calibration

Allow the pressure in the Convector gauge to rise above the Calibration Limit shown in Table 3-3. Read the local atmospheric pressure on an accurate barometer.

1. Press the UP or DOWN button until “Calibrate” is displayed and press the ENTER button. “Calibrate ATM 760” (actual reading) is displayed.
2. If “Invalid Pressure for CAL” or “Invalid Function NIST CAL” is displayed, calibration will not be possible.
3. Press the UP or DOWN button to calibrate at any pressure between 400 and 999 Torr, then press the ENTER button to calibrate.

To reset VAC and ATM back to their original factory settings, turn OFF the Controller and hold the ENTER button while turning ON power to the controller. "Factory CAL" is displayed for approximately three seconds. The controller will then resume normal power-on operation.

### **3.11.4 Convectron Gauge Use Below $10^{-3}$ Torr**

During a fast pumpdown from atmosphere, thermal effects will prevent the Convectron gauge from tracking pressure accurately below  $10^{-3}$  Torr. After waiting about 15 minutes, indications in the  $10^{-4}$  range will be valid and response will be rapid. Zero adjustment at vacuum may be performed at this time (or sooner if readings in the  $10^{-4}$  range are not needed). In the  $10^{-4}$  Torr range, the indication is resolved to about 0.1 mTorr provided the instrument has been carefully zeroed at vacuum. For accurate use in the  $10^{-4}$  range, zeroing should be repeated frequently.

### **3.11.5 NIST Traceable System Calibration**

Brooks Automation offers a calibration service for the Series 475 Convectron gauge controller. A controller and Convectron gauge tube are calibrated as a system, the built-in calibration functions of the controller are locked, and a calibration certificate is provided to the customer.

*NOTE: When using a 475 Controller that is NIST calibrated for a specific gas, selecting any function to change the gas species or calibration will cause the display panel to indicate INVALID.*

#### **Controller Function After NIST Calibration**

The "Product Info" menu will display "NIST Calibration Yes". The controller cannot be calibrated: the "Calibrate VAC or ATM" menu indicates "INVALID", and the TS, TZ and FAC commands of the computer interface respond with "INVALID."

#### **Voiding the NIST Calibration**

To set VAC or ATM, thereby voiding the NIST traceable calibration, you must first unlock the calibration functions. Hold down the BACK and UP buttons during power up, or send the VC (Void Calibration) command through the computer interface. The "Product Info" menu will display "NIST Calibration NO" to indicate that the controller can now be calibrated. The controller can then be calibrated at vacuum or atmosphere as described in *Vacuum Calibration* and *Atmosphere Calibration* on page 48.

*NOTE: Once the NIST calibration has been voided, the settings cannot be restored. The Controller and Convectron gauge must be returned to the factory for NIST calibration.*

Hold down the ENTER button during power up to restore the factory calibration settings, but not the NIST calibration settings.

**3.12 Convectron Gauge  
Analog Output Signal**

A voltage output signal proportional to the common logarithm of the pressure indication is provided on the rear panel of the controller via a standard 1/8 inch miniature phone jack.

If graphed on loglinear axes, the output voltage is linear in proportion to the log of pressure (see Figure 3-11). The analog output is 1 volt per decade of pressure with a factory adjusted output of 0 volts at  $1.0 \times 10^{-4}$  Torr. An alternate analog output format that has a built-in 1 Volt offset, which has 1 V to 8 V range, can be selected.

The voltage signal is smooth and continuous throughout all the decades of pressure measurement. This format is useful for computerized data acquisition because a simple equation (finding the common antilogarithm) may be programmed to calculate pressure from the voltage output.

An output voltage of 10 V indicates the gauge is unplugged or faulty.

Also, a selectable non-linear (S-curve) signal (0 to 9 V) that is backwards compatible with older Convectron gauge controllers is available.

In addition, a programmable offset of 0.1 V to 0.5V can be entered for the analog output signal. The offset voltage signal can be selected and programmed by using the Menu buttons on the front of the controller.

Figure 3-11 Convectron Gauge Analog Output vs. Pressure

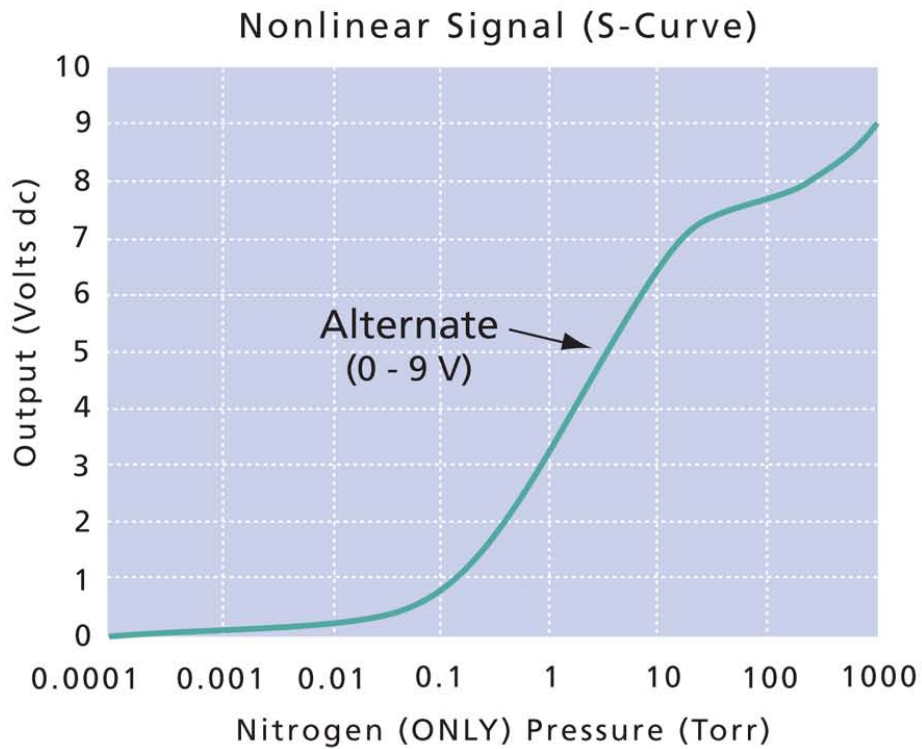
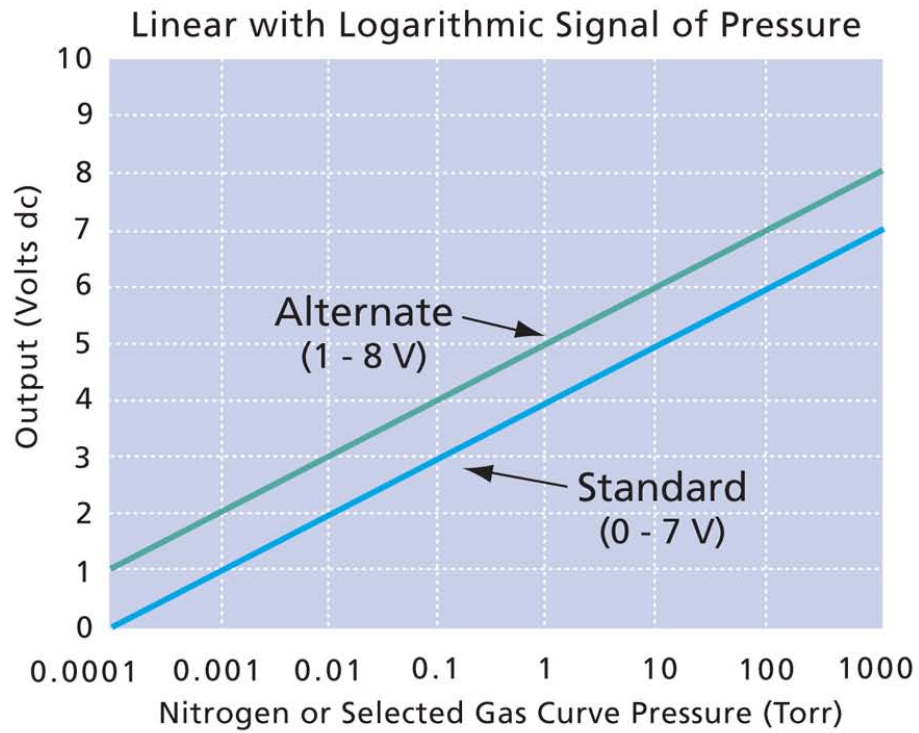

**3.12.1 Default Analog Output of 0 to 7 V**

The output equations for 0 to 7 V are:

$$P = 10^{V-4} \text{ Torr}$$

$$P = 10^{V-4} \text{ mbar}$$

$$P = 10^{V-2} \text{ Pa}$$

Where:

P = Pressure

V = Analog Output Voltage

**3.12.2 Optional Analog Output of 1 to 8 V**

In some applications a 0 V output is used to indicate that the controller is off. To accommodate these situations a one volt offset is available as an alternative.

For this Alternate output format, a -0.0 indication produces 0.5 V output. A 10 V output means the gauge is unplugged or faulty.

If the output is adjusted to 1V at  $10^{-4}$  Torr ( $10^{-2}$  Pa), the output equation for 1 to 8 V is:

$$P = 10^{V-5} \text{ Torr}$$

$$P = 10^{V-5} \text{ mbar}$$

$$P = 10^{V-3} \text{ Pa}$$

**3.12.3 Optional Nonlinear Analog Output "S Curve"**

In some applications a 0 to 9 V output similar to the Series 275 controller output is desirable. To accommodate these situations a third analog output option is available.

A 10 V output means the gauge is unplugged or faulty.

**3.13 Analog Output Mode Programming**

1. Press the UP or DOWN button and select "Setup Parameters" with the ENTER button.
2. Press the UP or DOWN button and select "Analog Out Mode" with the ENTER button.
3. The current mode will show in reverse video. Press the UP or DOWN button to select "I V/Decade, I-8V" or "I V/Decade, 0-7V" or "S Curve, 0-9V".
4. Press the ENTER button to save the mode.
5. Press the BACK button a few times or wait one minute to return to pressure display.

**3.14 Process Control Setpoints & RS-232**

Programming the process control setpoints is explained in *Chapter 4*.

Configuration of the RS-232 interface is explained in *Chapter 5*.

## Chapter 4 Process Control

The process control option provides a convenient method of organizing and establishing automatic control of vacuum system operations. Control is based on configuring pressure setpoints to activate relays in the controller.

Two process control setpoints are available to provide control of other vacuum system equipment such as valves, pumps, heaters, alarms, and safety interlocking.

### 4.1 Process Control Setup

Before putting the controller into operation, you must perform the following procedures:

1. Use the "Product Info" menu item to identify the process control options installed in your unit. (See *Product Information* on page 27.)
2. Install the controller in accordance with the instructions in *Chapter 2*.
3. Use Table 4-1 to record the proposed activation and deactivation setpoints for each relay.

**Table 4-1 Relay Setpoints**

Relay	Activation setpoint (Pressure)	Deactivation setpoint (Pressure)
Relay 1		
Relay 2		

4. Develop a circuit schematic that specifies exactly how each piece of system hardware will connect to the controller relays.
5. Attach a copy of the process control circuit diagram to this manual for future reference and troubleshooting.
6. Do not exceed the relay ratings listed below:  
**Relay Configuration:** Normally Closed, Normally Open, Common (NC, NO, C).  
**Relay Contact Rating:** 5 A, 250 VAC, or 30 Vdc, resistive load.
7. If you desire application assistance, contact a Granville-Phillips application engineer. See *Customer Service* on page 77 for contact information.

Figure 4-1 Convectron Gauge, Output, and Power Connections

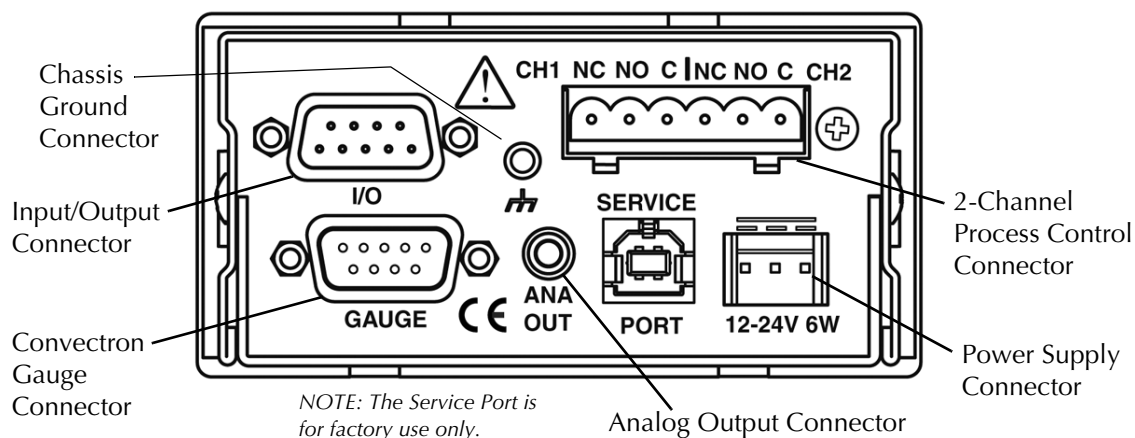

#### 4.2 Connecting Process Control Relays

The process control connector, located on the rear panel of the controller, is marked with letters identifying each pin. See *Connectors* on page 22.

A mating connector (Granville-Phillips part number 0167820) is supplied in the hardware kit.

1. Using a drawing of the process control output connector and the circuit schematics you have prepared, make a cable to connect the various system components to be controlled. Clearly label each lead to help prevent costly mistakes.
2. Connect the component end of the cable to the system component to be controlled. This is done with a small screwdriver and screw-post connections.
3. Plug the connector into the back of the 475 Controller.

#### 4.3 Setpoint Display and Adjustment

1. On the front panel of the 475 Controller, press the UP or DOWN button to scroll to "Configure" and press the ENTER button.
2. Press the UP or DOWN button to select "Setpoint 1" or "Setpoint 2" and press the ENTER button.
3. Press the UP or DOWN button to select "Value", "Hysteresis", "Polarity", or "Relay" and press the ENTER button.

##### **Value**

1. The indicated setting will show in reverse video. Press the UP or DOWN button to select the desired setpoint.
2. Press the ENTER button to save the selection.
3. Press the BACK button a few times or wait one minute to return to pressure display.

##### **Hysteresis**

1. The indicated setting will show in reverse video. Press the UP or DOWN button to select the desired "Hysteresis" percentage.
2. Press the ENTER button to save the selection.
3. Press the BACK button a few times or wait one minute to return to pressure display.

**Polarity**

1. The indicated setpoint polarity setting will show in reverse video. Press the UP or DOWN button to select "Normal" or "Reverse".
2. Press the ENTER button to save the selection.
3. Press the BACK button a few times or wait one minute to return to pressure display.

**Relay**

1. The indicated setpoint relay setting will show in reverse video. Press the UP or DOWN button to select "Enabled" or "Disabled".
2. Press the ENTER button to save the selection.
3. Press the BACK button a few times or wait one minute to return to pressure display.

**4.4 Process Control Tips**

Relay actuation occurs when the pressure reading is greater than the setpoint for reverse polarity or less than the setpoint for normal polarity. A default 10% hysteresis is programmed into each setpoint for returning pressures.

Table 4-2 exemplifies this function using an assumed setpoint pressure. The example also assumes that the polarity is set to activate the relay when pressure falls below the setpoint.

**Table 4-2 Setpoint Normal Polarity ( - minus )**

Setpoint Pressure	Pressure Change	Relay Transition Pressure
$6.30 \times 10^{-2}$	Falling	$< 6.30 \times 10^{-2}$
$6.30 \times 10^{-2}$	Rising	Releases at $6.30 \times 10^{-2} + 10\% = 6.93 \times 10^{-2}$

**Table 4-3 Setpoint Reverse Polarity ( + plus )**

Setpoint Pressure	Pressure Change	Relay Transition Pressure
$6.30 \times 10^{-2}$	Rising	$> 6.30 \times 10^{-2}$
$6.30 \times 10^{-2}$	Falling	Releases at $6.30 \times 10^{-2} - 10\% = 5.67 \times 10^{-2}$

**4.5 Process Control Factory Default Settings**

Table 4-4 lists the factory default the settings for the process control relays.

**Table 4-4 Process Control Relay Default Settings**

Feature	Default Setting
Setpoint	1E-4
Relay Polarity	Activation below pressure setpoint Normal Polarity / minus ( - )
Returning Pressure Hysteresis	10%

**4.6 Process Control Relay Trip Points**

The 475 Controller is shipped from the factory with the trip point relays set to a pressure of 1.00E-4. The relays need to be adjusted for your application. The trip point may be set from  $1 \times 10^{-4}$  to 100. The pressure measurement unit restricts the trip points at the extremes of the measurement range. A built-in default hysteresis of 10% prevents oscillation around the trip point. In the default mode, relays activate with decreasing pressure and deactivate at a 10% higher pressure than the activation pressure, as illustrated in Figure 4-2.

You can reverse relay polarity, so relays activate with increasing pressure and deactivate at a lower pressure than the activation pressure.

**Figure 4-2 Process Control Relay Behavior**

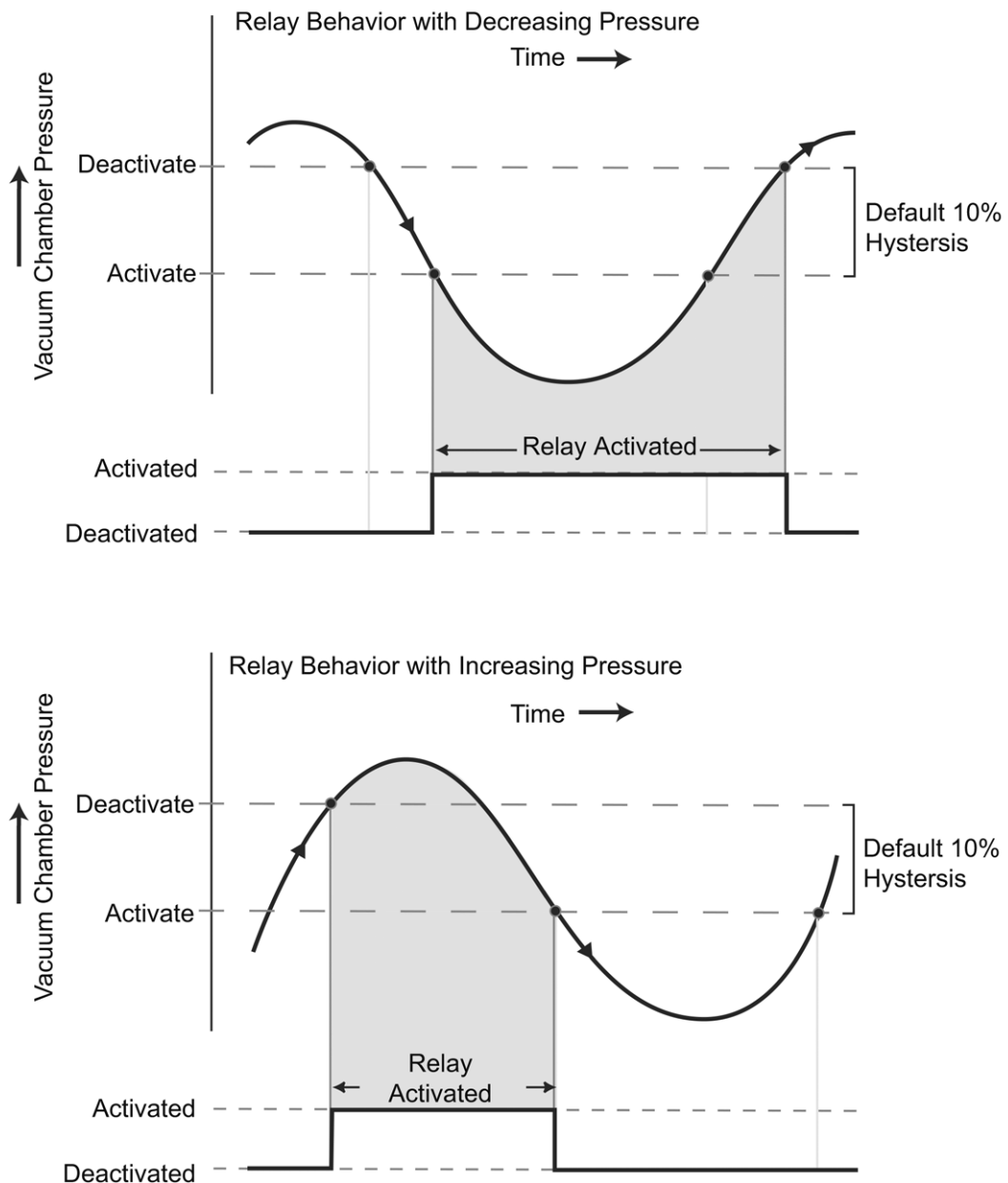

# Chapter 5 RS-232 Interface

## 5.1 RS-232 Theory of Operation for the 475 Controller

The RS-232 interface option permits data output to, and Convector gauge control by, a host computer. Output control is by a command-response mechanism and a hardwire control line between RTS (Request To Send) and CTS (Clear To Send). If you have this controller option, configure it to your system requirements as directed in this chapter.

*NOTE: CTS and RTS are used only if handshaking is enabled.*

The DSR (Data Set Ready) line is set 'true' upon power up to indicate it is on-line and is ready to receive data. When the controller receives a start bit on the received data line, it will input and buffer a character. The controller will continue to receive and buffer characters until the terminator (carriage return) is received.

Upon receiving the terminator, the controller will assert the RTS line as a holdoff to prevent the host computer from attempting to transmit further data until the message just received has been decoded and a reply has been output.

During output of the reply, the incoming handshake line CTS is tested prior to beginning transmission of each character. The controller will wait until CTS is true before beginning transmission of a character, and will not test them again until ready to begin transmitting the next character.

After transmitting the terminator, the controller will negate RTS and wait for the next incoming message.

## 5.2 Connecting the RS-232 Computer Interface

Figure 5-1 Control Unit Rear Panel Showing RS-232 (I/O Output) Connector

See I/O (RS-232) 9-Pin Connector (pins) on page 22

NOTE: The Service Port is for factory use only.

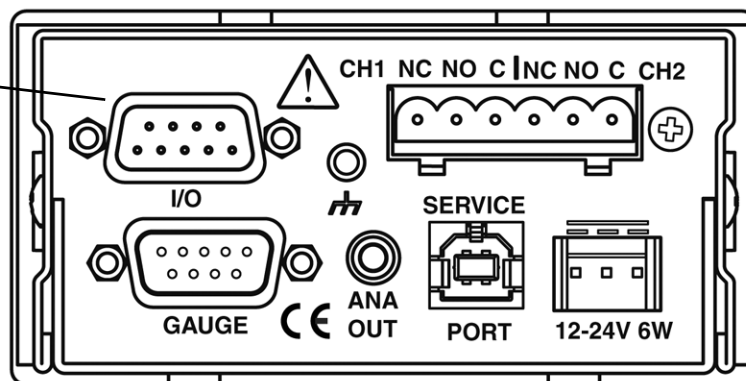

A mating 9-pin D type connector is supplied in the hardware kit. Use shielded cable to minimize electromagnetic radiation or susceptibility. Ground the shield to the metal connector shell or to Pin 5. Do not connect the shield to Pin 7.

**Table 5-1 RS-232 Connector Pin Assignments**

Signal	Pin Number	Direction
Signal Ground	5	–
Transmitted Data (TXD)	2	To Computer
Received Data (RXD)	3	To Controller
Data Set Ready (DSR)	6	To Computer
Clear To Send (CTS)	7	To Controller
Request To Send (RTS)	8	To Computer
Not Used	1 and 4	

**Table 5-2 Computer Cable Pin Assignments for a 9 Pin Connector**

Controller Connector	PC Connector	Cable Pinout	Signal at Computer	Signal at 475 Controller
DB9S	DE9P	DE9S (DB9P)		
2	2	2 (3)	RXD	TXD
3	3	3 (2)	TXD	RXD
5	5	5 (1)*	Signal Ground	Signal Ground
8	8	8 (5)	CTS	RTS
7	7	7 (4)	RTS	CTS
6	6	6 (6)	DSR	DSR

\* Use metal connector shell to provide shield wire ground.

### 5.3 RS-232 Handshake

Normal handshake control can be accomplished using the command-response mechanism, and a hard-wired handshake by using the RTS/CTS connection as outlined in Table 5-3. This RTS/CTS connection has to be enabled via a separate function.

**Table 5-3 Handshaking Outputs from Controller**

Line	Pin	Description	Factory Setting
RTS	8	Output from controller to be tied to the computer's CTS input for hardware handshake control	Always high
CTS (input)	7	Input to controller. Used to sense the RTS line of the computer before sending data	No control of data output
DSR (output)	6	Set high when the controller is turned ON	Not applicable

**Table 5-4 RTS/CTS Handshake Display Readouts**

Display Readout	Byte Format
"Handshake disabled"	Disable RTS/CTS handshake
"Handshake enabled"	Enable RTS/CTS handshake

When the handshake is enabled:

1. Upon receiving the terminator, the controller will assert the RTS line as a holdoff to prevent the host computer from attempting to transmit further data until the message just received has been parsed and a reply has been sent.
2. During the transmission of the reply, the CTS incoming handshake line is tested prior to transmission of each character. The controller will wait until CTS is true before beginning transmission of a character, and will not test it again until ready to begin transmitting the next character.
3. After transmitting the terminator, the controller will negate RTS and wait for the next incoming message.

To summarize:

- **CTS (Clear To Send):** This is sent by the computer to indicate that the controller may transmit the next byte in its message. As shipped from the factory, this line is disabled. The controller will automatically assume the host is ready to receive.
- **RTS (Request to Send):** This is negated by the controller at power-up. The RTS is asserted by the controller upon receipt of a message terminator. RTS is negated after transmitting the terminator of the controller's response to that message.

#### 5.4 Command-Response Timing

The speed of the response from the controller varies depending on the type of command being carried out. All commands will cause a response to begin in less than 100 msec. Depending on the selected baud rate, there will be an additional delay as noted in Table 5-5 for the 9-character response from the controller. The response length will vary from nine characters (see the specific command).

**Table 5-5 TX Time of Response**

Baud Rate	TX Response Time T (Data to Host)
38,400	2.4 msec
19,200	4.7 msec
9,600	9.4 msec
4,800	18.7 msec
2,400	37.5 msec
1,200	75 msec

**5.5 Preparing the RS-232  
Computer Interface**

Check the user's manual for the host computer to be sure the protocol used is compatible with that established via the configuration of the RS-232 controller.

Communication with the control unit is via ASCII strings. A message consists of a command and a command modifier, followed by a terminator. The message may contain leading spaces, and the command and modifier may optionally be separated by spaces or commas. No spaces may appear within the command or the modifier, only between them.

The terminator expected by the control unit is an ASCII carriage return, the OD<sub>hex</sub> character, denoted in this instruction manual by the ↵ symbol. The line feed is optional, and messages terminated with only the carriage return will be accepted. Note that the LF (line feed) terminator may be appended automatically by the host computer's interface software to the message string supplied by the user. This line feed will be ignored.

If extra characters are found in the message after it has been successfully interpreted but before the terminator, they will be ignored. Characters can be upper- or lower-case. All messages to the controller will receive a reply, consisting of an ASCII string of upper-case letters terminated with ↵. Pressures will be returned in the format X.XXE±XX.

## 5.6 RS-232 Command Syntax

A command from the host must include data and a terminator (data)(terminator). The terminator is an ASCII carriage return, the  $OD_{hex}$  character, denoted here by the  $\downarrow$  symbol.

The data field is explained in the command descriptions. All alpha characters can be upper or lower case.

All data fields responses will contain up to 9 upper case alphanumeric characters. A response of "SYNTAX ERR" is caused by an incorrect character string from the host. A response of "F P ERR" is displayed when a function is set via the front panel on the 475 Controller (See Chapter 3).

**Table 5-6 List of RS-232 User Commands**

Command	Description	Page	RST to Change
AO	Set analog output mode	62	
AOO	Get/Set analog output offset	62	
CA	Get calibration status	62	
DT	Perform diagnostic tests	63	
FAC	Set calibration to factory defaults	63	
GS	Modify gas species settings	64	
HA	Set handshaking	64	Yes
KP	Enable/Disable keypad	65	
LPF	Enable/Disable LPF (Low-Pass Filter)	65	
PC	Get or set process control setpoint value	65	
PCE	Enable/Disable relays	66	
PCH	Get or set process control setpoint hysteresis	66	
PCP	Get or set process control setpoint polarity	66	
PD	Modify programmable delay settings	67	
RD	Read the pressure	67	
RST	Reset the controller	68	
RU	Read units of pressure	68	
SB	Set the baud rate	68	Yes
SN	Get the serial number	68	
SPE	Set parity and data bits (Even)	69	Yes
SPN	Set parity and data bits (None)	69	Yes
SPO	Set parity and data bits (Odd)	69	Yes
ST	Get/Set Convectron gauge sensor type	69	
SU	Set the units of pressure	69	
TS	Set span	70	
TZ	Set zero	70	
UC	Restore/save user configuration.	71	
VC	Void NIST calibration	71	
VER	Read code version	71	
	RS-232 Troubleshooting	72	
	RS-232 Error Messages	72	

<b>AO</b>	<b>Analog Output</b>	<p>Definition: Get/Set the analog output mode.</p> <p>Modifiers: 1, 2, or 3</p> <p>Response: PROGM OK↵</p> <p>Example:</p> <p>From host computer: AO1↵ (or AO2, or AO3)</p> <p>From 475 controller: PROGM OK↵</p> <ul style="list-style-type: none"> <li>• Command AO1 sets the analog output to log 0-7V.</li> <li>• Command AO2 sets the analog output to log 1-8V.</li> <li>• Command AO3 sets the analog output to log 0-9V S-curve. (See Figure 3-11 on page 51.)</li> </ul> <p><i>Note: Applies ONLY when N<sub>2</sub> is selected.</i></p> <ul style="list-style-type: none"> <li>• Invalid - displayed if a gas other than N<sub>2</sub> is selected.</li> </ul>
<b>AOO</b>	<b>Analog Output Offset</b>	<p>Definition: Get/Set analog output offset voltage.</p> <p>Modifiers: 0 to 0.5</p> <p>Response: PROGM OK↵ Set analog output offset voltage.</p> <p>Example:</p> <p>From host computer: AOO 0.2↵</p> <p>From 475 controller: PROGM OK↵ Sets analog output offset voltage by 0.2V.</p>
<b>CA</b>	<b>Read NIST Traceability Calibration Status</b>	<p>Check status of NIST Traceable System Calibration:</p> <p>Definition: Calibration status.</p> <p>Modifiers: None.</p> <p>Response: CAL CERT↵ NIST traceable calibration is valid. CAL VOID↵ NIST traceable calibration is void.</p> <p>See <b>VC</b> to void the NIST calibration.</p>

<b>DT</b>	<b>Diagnostics Test</b>	Definition:	Perform diagnostics tests on A/D and analog out.
		Modifiers:	C, CS, CE, CP, CV, CD A, A#, AD
		Response:	See the examples, below.  (NOTE: F P ERR↵ = Diagnostics are being performed via the front panel.)

Examples:

Command Root	From Host Computer	From 475 Controller
<b>DT</b>	DT↵	PASS↵ Run auto test on A/D and analog output.
		FAIL↵ Both functions failed.
		AD FAIL↵ A/D failed.
<b>DTC</b>		AO FAIL↵ Analog output failed.
	DTC↵	PASS↵ Run auto test on A/D.
		FAIL↵ A/D failed.
	DTCS↵	1↵ Simulator enabled.
		0↵ Simulator disabled.
	DTCD↵	PROGM OK↵ Disable simulator.
	DTCE↵	PROGM OK↵ Enable simulator.
	DTCP1.00E-3↵	PROGM OK↵ Set simulator pressure.
	DTCV5.534↵	PROGM OK↵ Set simulator bridge voltage.
	<b>DTA</b>	DTA↵
		FAIL↵ Analog output test failed.
DTA5.00↵		PROGM OK↵ Set analog output voltage.
DTAD↵		PROGM OK↵ Resume pressure reporting to analog output.

<b>FAC</b>	<b>Reset User Calibration to Factory Defaults</b>	Definition:	Set to factory defaults.
		Modifiers:	None.
		Response:	PROGM OK↵
		Example:	
		From host computer:	FAC↵
		From 475 controller:	PROGM OK↵

The FAC command will cause default VAC and ATM parameters to be programmed to the factory default settings. If the controller is NIST calibrated, the response for this command will be INVALID (see *NIST Traceable System Calibration* on page 49).

<b>GS</b>	<b>Gas Species</b>	Definition:	Get/Set gas species commands. See <i>Gas Species</i> on page 32 for a detailed explanation.
		Modifiers:	N <sub>2</sub> (Nitrogen), AR (Argon), HE (Helium), CO <sub>2</sub> (Carbon Dioxide), O <sub>2</sub> (Oxygen) FS (Factory Specified), CF (Correction Factor).
		Response:	See the examples, below.  (NOTE: F P ERR↵ = The gas species is being set via the front panel.)

Examples:

Command Root	From Host Computer	From 475 Controller
<b>GS</b>	GS↵	N <sub>2</sub> ↵ AR↵ HE↵, CO <sub>2</sub> ↵, O <sub>2</sub> ↵, FS↵, or CF↵ (FS = Factory Specified curve / CF = Correction Factor)
	GSN2↵ (or AR, HE, CO2, O2, FS, CF)	PROGM OK↵ Set the gas species to the gas being used.
		INVALID↵ The system is NIST calibrated.
	GSFS↵	INVALID↵ The data in memory is not valid or the system is NIST calibrated.
	GSCF↵	1.5↵ The correction factor being used. (CF of 1.5 in this example)
	GSCF 1.0↵	PROGM OK↵ Set the gas species to a new correction factor (0.1 to 1.5 in 0.1 increments) (this example: 1.0 CF).
	GSCF 1.0, 200↵	PROGM OK↵ Set the gas species to a new correction factor, and maximum pressure (0.1 to 1.5 CF and 1mTorr to 999 Torr) (this example: 1.0 CF and 200 Torr).
	GSCFP↵	1.00E+2↵ Get current max pressure setting (this example: 100 Torr).
	GSCFP 150↵	PROGM OK↵ Set the gas species to the correction factor, and maximum pressure (1mTorr to 999 Torr) (this example: 150 Torr).

<b>HA</b>	<b>Enable/Disable RTS/CTS Handshake</b>	Definition:	Enables or disables RTS/CTS handshake.
		Modifiers:	1 or 0 (1 = enable, 0 = disable).
		Response:	PROGM OK↵
		Example:	
		From host computer:	HA1↵
From 475 controller:	PROGM OK↵		

<b>KP</b>	<b>Keypad</b>	<p>Definition: Get the keypad status, or Enable/Disable the keypad on the 475 controller.</p> <p>Modifiers: 1 or 0 (1 = enable, 0 = disable).</p> <p>Response: PROGM OK↵</p> <p>Other possible responses:</p> <p>F P ERR↵ The keypad is being set via the front panel.</p> <p>Examples:</p> <p>From host computer: KP↵ Get the Keypad status (Enabled or Disabled)</p> <p>From 475 controller: 1↵ or 2↵</p> <p>From host computer: KP1↵ Enable keypad (KP0↵ = Disable keypad)</p> <p>From 475 controller: PROGM OK↵</p>
<b>LPF</b>	<b>Low-Pass Filter</b>	<p>Definition: Enables another order of low-pass filtering for the pressure reading.</p> <p>Modifiers: 1 or 0 (1 = enable, 0 = disable).</p> <p>Response: PROGM OK↵</p> <p>Other possible responses:</p> <p>F P ERR↵ The Low-Pass Filter is being set via the front panel.</p> <p>Example:</p> <p>From host computer: LPF1↵ Enable Low-Pass Filter (LPF0↵ = Disable)</p> <p>From 475 controller: PROGM OK↵</p>
<b>PC</b>	<b>Set Setpoint Pressure</b>	<p>Definition: Setpoint pressure setting (factory default is 1E-4).</p> <p>Modifiers: 1 or 2; X.XXE±XX (pressure).</p> <p>Response: X.XXE±XX↵ (pressure)</p> <p>Example:</p> <p>From host computer: PC 1 4.35E-02↵</p> <p>From 475 controller: PROGM OK↵</p>

## PCE Relays

Definition: Enable/Disable relays.  
Modifiers: 1 or 0 (1 = enable, 0 = disable).  
Response: PROGM OK↓  
Other possible responses:  
F P ERR↓ The relays are being set via the front panel.  
Examples:

Command Root	From Host Computer	From 475 Controller
PCE	PCE↓ Get relay status.	PROGM OK↓
	PCE01↓ Enable Relay 1, disable relay 2	PROGM OK↓
	PCE10↓ Enable Relay 2, disable relay 1	PROGM OK↓
	PCE11↓ Enable both relays.	PROGM OK↓
	PCE00↓ Disable both relays.	PROGM OK↓

If you disable a relay, you must re-enable it to make it operable. The previous relay settings are still applicable and can be recalled.

Enabling or disabling a relay that doesn't exist results in a syntax error.

## PCH Process Control Setpoint Hysteresis

Definition: Set the process control setpoint hysteresis.  
Modifiers: 1, or 2 (for setpoint 1 or 2).  
Response: PROGM OK↓  
Other possible responses:  
F P ERR↓ The hysteresis is being set via the front panel.  
RANGE ERR↓ The value entered is <5 or >1000.  
Examples:

From computer: PCH1↓ Get setpoint 1 hysteresis.  
From 475 controller: 200↓ Setpoint 1 hysteresis is 200%  
From host computer: PCH2 100↓ Set setpoint 2 hysteresis.  
From 475 controller: PROGM OK↓ The setpoint hysteresis is 100%.

## PCP Set Relay Polarity

Definition: Get/Set the polarity of the relay activation (factory default is -).  
(-) relay activation = < the current pressure setting.  
(+) relay activation = > the current pressure setting.  
Modifiers: 1 or 2; + or -  
Response: PROGM OK↓  
Examples:  
From host computer: PCP1↓ Get polarity setting for Relay 1.  
From 475 controller: POS POL↓ or NEG POL↓  
From host computer: PCP1 +↓ Set polarity to +  
From 475 controller: PROGM OK↓

If the PCP command is sent while the setpoints are being changed by the 475 controller, the command is disregarded and the response is F P ERR. The controller setting has priority over the PCP command to change the setpoints. (See *Setpoint Parameters* on page 29.)

**PD Set Delay**

Definition: Pressure filtering response delay.

Modifiers: 0 to 200 ms

Response: PROGM OK↵

Other possible responses:

F P ERR↵ The delay is being set via the front panel.

Examples:

Command Root	From Host Computer	From 475 Controller
PD	PD↵ Get (show) the current delay setting.	150↵
	PD10↵ Set 10 ms delay.	PROGM OK↵
	PD150↵ Set 150 ms delay.	PROGM OK↵

Response Delay provides a delayed readout of the indicated pressure. You can set the delay time in milliseconds for the 475 Controller to display a pressure reading. Also, see LPF.

**RD Read Pressure**

Definition: Read Convectron gauge pressure response.

Modifiers: None.

Response: Pressure Value X.XXE±XX↵

Simulated Pressure Reading TX.XXE±XX↵

Other possible responses:

OPN SNSR↵ Defective transducer.

SNSR UNP↵ Sensor is unplugged.

SNSR OVP↵ Pressure higher than 999 Torr, or gasses other than nitrogen in the system. (Atmosphere pressure of helium will cause this response.)

Example:

From host computer: RD↵

From 475 controller: 9.34E-02↵

- ASCII string representing pressure in scientific notation. Three significant digits except in  $10^{-3}$  Torr range with two significant digits and a zero filler,  $10^{-4}$  Torr range with one significant digit with two zero fillers.
- While at vacuum, the output should be 0.00E-04 (= 0.0 mTorr displayed.) Output 0.00E+00 (= -0.0 mTorr displayed) occurs when the transducer voltage at vacuum has drifted lower than the Convectron gauge can sense. The number received at vacuum will fluctuate under normal operation, but if it reads negative consistently, calibration may be required. See *TZ Calibrate at Vacuum* on page 70.

<b>RST</b>	<b>Reset Controller</b>	Definition:	Reset controller.
		Modifiers:	None.
		Response:	None.
		Example:	
		From host computer:	RST↵
		From 475 controller:	None
			The RST command will reset the controller as if the power had been cycled. The RST command has no response but resets the controller operation. Communication is re-enabled in two seconds.
<b>RU</b>	<b>Read Pressure Unit</b>	Definition:	Identifies the selected units of pressure.
		Modifiers:	Torr, mbar, Pascal.
		Response:	None.
		Other possible responses:	
		F P ERR↵	The pressure unit is being set via the front panel.
		Example:	
		From host computer:	RU↵
		From 475 controller:	TORR
			See SU (Set Unit of Pressure) to change the display form unit of measure to another.
<b>SB</b>	<b>Set Baud Rate</b>	Definition:	Set baud rate. (Factory default is 19200)
		Modifiers:	1200, 2400, 4800, 9600, 19200, 38400.
		Response:	PROGM OK↵
		Example:	
		From host computer:	SB19200↵
		From 475 controller:	PROGM OK↵
			The baud rate needs to be set at a valid rate, i.e., 1200, 2400, 4800, 9600, 19200, 38400. If the rate is set to an odd value, for example 2234, the controller will stay at the present rate and respond with SYNTAX ERR.
			See <i>Command–Response Timing</i> on page 59.
			The controller will continue to operate at the old baud rate setting until power is cycled or the RST command is sent.
<b>SN</b>	<b>Serial Number</b>	Definition:	Get the serial number of the 475 Controller.
		Modifiers:	None.
		Response:	475A1234↵
		Example:	
		From host computer:	SN↵
		From 475 controller:	475A1234↵
			The serial number can be up to 16 characters long. Leading zeros are trimmed.

<b>SPE</b>	<b>Set Parity to 7 Bits/Even Parity Check</b>	<p>Definition: Set bits/parity to 7 bits/even, 1 stop bit.</p> <p>Modifiers: None.</p> <p>Response: PROGM OK↵</p> <p>Example:</p> <p>From host computer: SPE↵</p> <p>From 475 controller: PROGM OK↵</p> <p>To enable changes after sending the SPE command, cycle power or send the RST command.</p>
<b>SPN</b>	<b>Set Parity to 8 Bits/No Parity Check</b>	<p>Definition: Set bits/parity to 8 bits/none, 1 stop bit. (Factory default)</p> <p>Modifiers: None.</p> <p>Response: PROGM OK↵</p> <p>Example:</p> <p>From host computer: SPN↵</p> <p>From 475 controller: PROGM OK↵</p> <p>To enable changes after sending the SPN command, cycle power or send the RST command.</p>
<b>SPO</b>	<b>Set Parity to 7 Bits/Odd Parity Check</b>	<p>Definition: Set bits/parity to 7 bits/odd, 1 stop bit.</p> <p>Modifiers: None.</p> <p>Response: PROGM OK↵</p> <p>Example:</p> <p>From host computer: SPO↵</p> <p>From 475 controller: PROGM OK↵</p> <p>To enable changes after sending the SPO command, cycle power or send the RST command.</p>
<b>ST</b>	<b>Get/Set Convectron Gauge Sensor Type</b>	<p>Definition: Get/Set the gauge sensor type (Gold-plated tungsten or Platinum)</p> <p>Modifiers: Au, Pt</p> <p>Response: AU↵ or PT↵ PROGM OK↵</p> <p>Examples:</p> <p>ST↵</p> <p>AU↵ PROGM OK↵ (Gold-Plated Tungsten)</p> <p>PT↵ PROGM OK↵ (Platinum)</p>
<b>SU</b>	<b>Set Unit of Pressure</b>	<p>Definition: Selects and sets the units of pressure.</p> <p>Modifiers: T, M, or P (Torr, mbar, or pascal).</p> <p>Response: PROGM OK↵</p> <p>Other possible responses:</p> <p>F P ERR↵ The pressure unit is being set via the front panel.</p> <p>Example:</p> <p>From host computer: SUT↵</p> <p>From 475 controller: PROGM OK↵</p>

<b>TS</b>	<b>Calibrate at Atmosphere</b>	<p>Definition: Set span (typically at atmospheric pressure).</p> <p>Modifiers: Pressure value above 399 Torr (for N<sub>2</sub>).</p> <p>Response: PROGM OK↵</p> <p>Other possible responses:</p> <p>GAIN LIM↵ Gain programmed at limit. Readout will be the pressure at maximum TS setting.</p> <p>OPN SNSR↵ Sensor defect, no change in programming. See <i>Convectron Gauge Test Procedure</i> on page 81.</p> <p>SNSR UNP↵ Sensor unplugged, no change in programming.</p> <p>RANGE ER↵ Command error. TS must be set above 399 Torr, and system pressure must be above 399 Torr.</p> <p>INVALID↵ System is calibrated and locked.</p> <p>F P ERR↵ Span is set through the front panel of the controller.</p> <p>Example:</p> <p>From host computer: TS 7.60E+02↵</p> <p>From 475 controller: PROGM OK↵</p> <ul style="list-style-type: none"> <li>• Send the TS command only at pressures above 399 Torr. The controller will respond with range error if done near vacuum. The change occurs as soon as the function is performed.</li> <li>• If the controller is system-calibrated, the response for this command will be INVALID (see <i>NIST Traceable System Calibration</i> on page 49).</li> </ul>
<b>TZ</b>	<b>Calibrate at Vacuum</b>	<p>Definition: Set zero.</p> <p>Modifiers: 0 or pressure below <math>1 \times 10^{-1}</math> Torr in scientific notation.</p> <p>Response: PROGM OK↵</p> <p>Other possible responses:</p> <p>OFST LIM↵ Offset programmed at limit. Readout will be the pressure at maximum TZ setting.</p> <p>OPN SNSR↵ Sensor defect. No change in programming. See <i>Convectron Gauge Test Procedure</i> on page 81.</p> <p>SNSR UNP↵ Sensor unplugged. No change in programming.</p> <p>RANGE ER↵ Command error. TZ must be set below <math>1 \times 10^{-1}</math> Torr, and system pressure must be below <math>1 \times 10^{-1}</math> Torr.</p> <p>INVALID↵ System is NIST calibrated and locked.</p> <p>F P ERR↵ Zero is set through the front panel of the controller.</p> <p>Examples:</p> <p>From host computer: TZ0↵</p> <p>From 475 controller: PROGM OK↵</p> <p>From host computer: TZ1.00E-02↵</p> <p>From 475 controller: PROGM OK↵</p> <ul style="list-style-type: none"> <li>• Send the TZ command only at pressures below <math>1 \times 10^{-1}</math> Torr. The response will be a range error if done near atmosphere. Change occurs as soon as the function is performed</li> </ul>

- If the controller is system calibrated, the response for this command will be INVALID (see *NIST Traceable System Calibration* on page 49).

## UC User Configurations

Definition: Save a program configuration or restore a previously saved configuration.

Modifiers: S (Save), R (Restore) or F (Factory) / 1, 2, or 3.

Response: PROGM OK↵

Other possible responses:

F P ERR↵ The settings are being set via the front panel.

Examples:

From host computer: UCS1↵

From 475 controller: PROGM OK↵ Save the settings to the specified slot (#1 in this example).

From host computer: UCR3↵

From 475 controller: PROGM OK↵ Restore the settings from the specified slot (#3 in this example).

“Save Configuration” allows the user to save up to three configurations in addition to the factory default configuration. Three different user settings can be programmed and saved. Each user setting will include the unique setpoint parameters, unit of measure, analog output setting, computer interface parameters, atmosphere and vacuum calibrations, gas species setting, and display options.

“Restore Configuration” allows the user to switch to any of the four saved configurations. Four different configurations (one factory default and three user-set configurations) can be programmed and saved. Each user setting will include unique setpoint parameters, unit of measure, analog output setting, computer interface parameters, atmosphere and vacuum calibrations, gas species setting, and display options. Initial user settings are programmed to the factory defaults.

## VC Void NIST Traceability Calibration

For NIST Traceable System Calibration:

Definition: Void calibration.

Modifiers: None.

Response: PROGM OK↵ (Calibration functions and gas settings are now unlocked.) GS, ST, TS, TZ, and FAC commands will now work.

## VER Read Version

Definition: Read code version.

Modifiers: None.

Response: Code version (alpha-numeric).

Example:

From host computer: VER↵

From 475 controller: 30134-A↵

## 5.7 RS-232 Troubleshooting

Because the RS-232 standard is found in various configurations, the first thing to do if trouble arises is check the following configuration options.

1. Check the RS-232 setting via the front panel of the 475 Controller.

Be sure the baud rate, character format and framing, and interface protocol are matched to the requirements of your host computer or terminal. Note that there may be several mismatched parameters. Check the handshaking to verify that the host computer and the 475 Controller settings match.

2. Check the interface wiring.

The pin designations for the RS-232 connector are shown in *RS-232 Connector Pin Assignments* on page 58. Note that the “received” and “transmitted” data lines are defined as seen by the controller. Many companies supply “null modems” or switch boxes for the purpose of re-configuring the control lines for particular applications. A standard 9-pin extension cable with a gender changer will work for many applications.

3. Check the command syntax.

Be sure the strings you send to the controller are in accordance with the syntax defined in *RS-232 Command Syntax* on page 61.

### 5.7.1 RS-232 Error Messages

If an error is found in the incoming message, the following messages will be returned in place of the normal response.

#### No Response or garbled output

- Baud rate incorrect
- Character length incorrect or stop bit(s) incorrect
- Bad cable or connection
- Command does not include OD<sub>hex</sub> (↵) terminator character

#### OVERRUN ERROR

Returned if the incoming message overflows the controller's buffer. This may indicate a flaw in the host software.

#### PARITY ERROR

Returned if the parity of a byte in the incoming message does not match that programmed by the RS-232 setting in the 475 Controller.

#### SYNTAX ERROR

Returned if the message fails to parse as a valid controller command.

#### F P ERROR

Returned if a function is being controlled via the front panel inputs on the 475 Controller.

#### INVALID

Function is not valid or possible at this time.

# Chapter 6 Diagnostics

The 475 has diagnostic functions to help determine if critical areas are operating correctly. Some diagnostic functions are continuously running and some require user interaction.

The Analog/Digital Converter (A/D) and the Analog Output are monitored continuously for errors.

**Figure 6-1 Diagnostics Flow Chart**

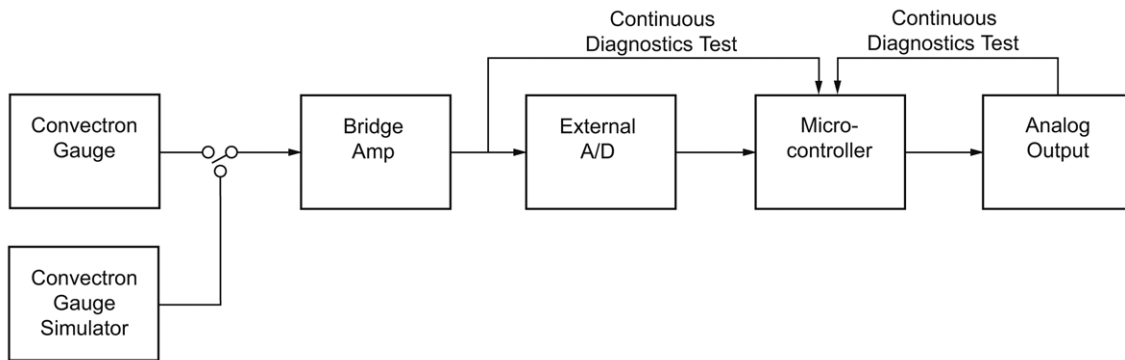

**Figure 6-2 Diagnostics Menu**

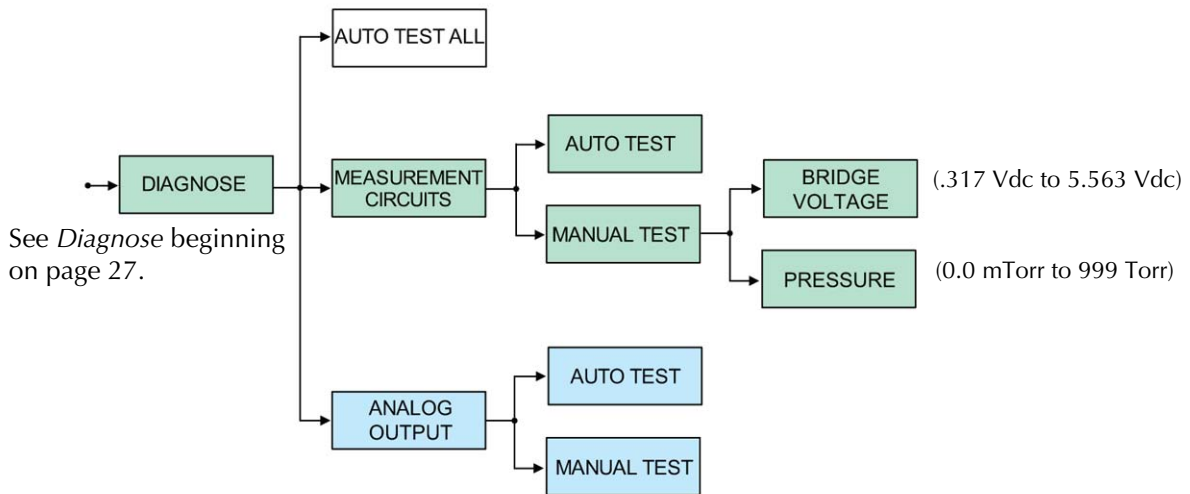

- 6.1 Continuous Diagnostics** The External A/D and the Analog Output are both monitored by the A/D on-board the micro controller automatically. Discrepancies are reported to the user through the errors "ADBAD" and "AOBAD".
- 6.2 Diagnostics Requiring User Interaction** User-interactive diagnostics can be accessed through the front panel or the RS-232 interface.

### 6.2.1 Analog Output

#### **Auto**

Runs the Analog Output through a voltage range and verifies the voltages are being met.

#### **Example:**

The pressure reported by the Analog Output is significantly different than the pressure reported by the display. With the Analog Output cable attached, the auto test reports a "FAIL". With the Analog Output cable disconnected, the auto test reports a "PASS". The problem is most likely external to the 475 Controller.

#### **Manual**

Allows the user to set the voltage to a specific voltage.

#### **Example:**

The Analog Output cable to a DMM is causing a small voltage drop because it is exceptionally long. Setting the manual test to 7V, the DMM reads 6.8V. A 0.2V offset can now be added to the Analog Output.

### 6.2.2 Measurement Circuits

#### **Auto**

Uses the Convector Simulator to check the External A/D and Bridge Amplifier through their ranges.

#### **Example:**

With the system at atmosphere, the controller is showing a "CABLE" error. The auto test reports a "FAIL" - the problem is most likely with the controller and not the cable or gauge.

#### **Manual**

Uses the Convector Simulator to set a bridge voltage or a pressure

#### **Example:**

When the Analog Output of the controller gets below a certain voltage (corresponds to a pressure), an external process is started. The vacuum system is fairly large, requiring a long pump-down time.

The Convector Simulator is used to set (simulate) the pressure below the threshold to see if the Controller is working and to see if the external process is started. This can be done without waiting to pump-down the system.

### 6.3 Convectron Gauge Simulator

The 475 has an in-circuit Convectron Gauge Simulator that can be used for self-diagnostics or system setup. The simulator is controlled by a PWM-controlled voltage source similar to the Analog Output. It is calibrated in the same manner as the Analog Output. Changing the voltage of the simulator forces the Bridge Amplifier to change the voltage across a resistor network - effectively simulating a Series 275 gauge. The Convectron simulator can be operated from the front panel on the 475 Controller, or through the RS-232 interface. "Test Mode" is displayed across the bottom of the front panel display screen when the Convectron Simulator is enabled. Access to the Simulator via the Controller front panel is by entering the Diagnose functions. See the 475 Controller Menu Flowchart on page 26 in the Operation Chapter and the Diagnostics Menu on page 73.

Two relays and an analog switch are used to switch the simulator in and out of the Bridge Amplifier network.

*NOTE: The Convectron Gauge Theory of Operation is explained in Section 3.8 on page 37.*

**Figure 6-3 Convectron Simulator Theory of Operation Schematic**

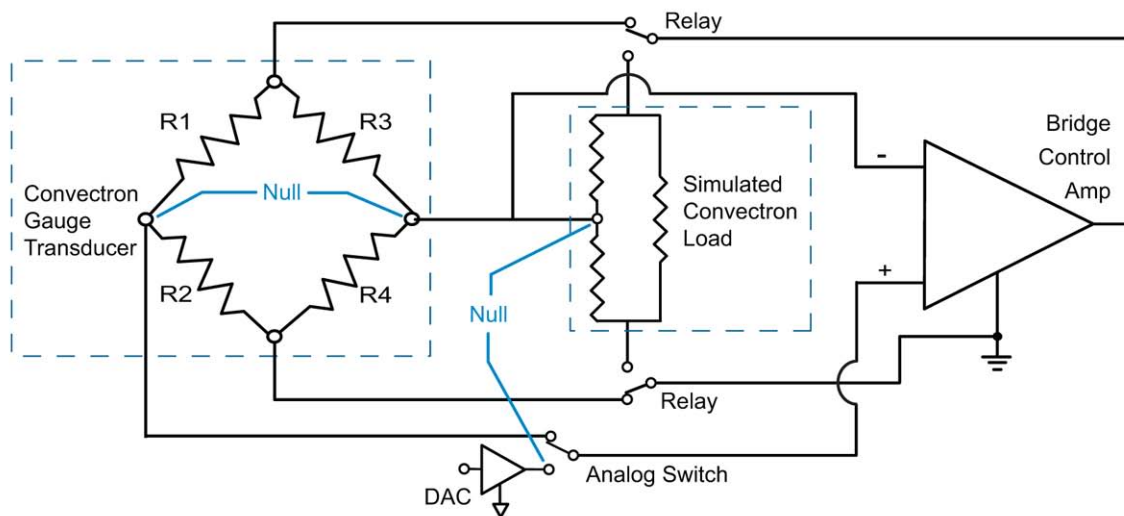

The 3 primary functions of the Convectron gauge Simulator are:

1. Send an Analog Output signal and Setpoint signals to the system process controller to simulate a system process operation.
2. Provide a self-diagnostics tool to check the 475 Controller to assure that it is operating properly.
3. Calibration of the analog inputs/outputs between the 475 Controller and the system process controller.

#### 6.3.1 Simulate a Process Operation Prior to Full System Integration

The Test and measurement circuit can be used to test and troubleshoot the 475 process control outputs prior to full vacuum chamber operation. The 475 Controller can be put in the manual mode and simulated pressures entered, causing the process control channels to change state.

During the initial setup of an Analog input channel for the System Process Controller for system process control, it may be helpful to calibrate the process voltage input to the pressure displayed on the 475 Controller. The

display and analog outputs can be set to a specific pressure, and the system process controller pressure input calibrated to match the pressure display of the 475 Controller.

The voltage displayed during the simulation mode is the bridge voltage of the Convector gauge and not the analog output voltage from the 475 Controller. To set the 475 Controller output voltage to a specific value, see the section on Analog Output Test.

If, during normal operation of a process, a non-functioning valve or lockout has locked the system operation, the Convector Simulator can be used to override the non-functioning system component.

### **6.3.2 Analog Output Tests**

The Analog output voltage of the 475 Controller can be set to a specific value for setting system calibration points. For instance, to calibrate the vacuum system process controller at 10 V, set the analog output voltage of the 475 Controller to 10V and calibrate the system process controller to display 10 V.

### **6.3.3 Controller Calibration Verification**

The voltage measurement circuit of the 475 Controller can be verified on a yearly basis to assure the unit remains properly calibrated. The output of the Simulated Measurement Circuit can be measured using an external voltmeter on pins 1 and 9 of the Convector gauge 9 pin D connector on the back of the Controller. (See Figure 2-12 on page 22.) Measurement of this simulated bridge voltage against the pressure displayed on the front panel is a check of the Controller's stability. This test verifies ONLY the factory calibration - Not a user applied calibration.

Vacuum calibration services are available through Granville Phillips for validating the accuracy of the Convector gauge and measurement system. Contact Customer Service for additional details.

## Chapter 7 Service and Maintenance

### 7.1 Customer Service

- Phone **+1-303-652-4400** or **+1-800-776-6543**, 8:00 AM to 5:00 PM Mountain Time Zone weekdays, excluding holidays within the USA.
- Phone **+1-800-367-GUTS (+1-800-367-4887)** 24 hours per day, seven days per week within the USA.
- Email *co-csr@brooks.com*
- For Global Customer Support, go to [www.brooks.com](http://www.brooks.com), click on Contact Us, then click on Global Offices to locate the Brooks Automation office nearest you.

### 7.2 Service Guidelines

Because the 475 Controller contains static-sensitive electronic parts, the following precautions must be followed when troubleshooting:

- Use a grounded, conductive work surface. Wear a high impedance ground strap for personal protection.
- Use conductive or static dissipative envelopes to store or ship static sensitive devices or printed circuit boards.
- Do not operate the controller with static sensitive devices or other components removed from the controller.
- Do not handle static sensitive devices more than absolutely necessary, and only when wearing a ground strap.
- Do not use an ohmmeter for troubleshooting MOS circuits. Rely on voltage measurements.
- Use a grounded, electrostatic discharge safe soldering iron.

This controller is designed and tested to offer reasonably safe service provided it is installed, operated, and serviced in strict accordance with these safety instructions.

### 7.3 Damage Requiring Service

*Turn OFF power to the controller* and refer servicing to qualified service personnel under the following conditions:

- If any liquid has been spilled onto, or objects have fallen into, the controller.
- If a circuit board is faulty.
- If the Convectron gauge sensing wire is open or the gauge is contaminated.
- If the controller has been exposed to moisture.
- If the controller does not operate normally even if you follow the operating instructions. Adjust only those controls that are explained in this instruction manual. Improper adjustment of other controls may result in damage and will often require extensive work by a qualified technician to restore the controller to its normal operation.
- If the controller has been dropped or the enclosure has been damaged.
- If the controller exhibits a distinct change in performance.

If the controller requires repair:

- See *Returning a Damaged Controller* on page 82,
- Phone **1-303-652-4400** or **1-800-776-6543** within the USA, or
- Email [co-csr@brooks.com](mailto:co-csr@brooks.com)



### WARNING

**Substitution or modifying parts can result in product damage or personal injury due to electrical shock or fire.**

- Install only those replacement parts that are specified by Granville–Phillips.
- Do not install substitute parts or perform any unauthorized modification to the controller.
- Do not use the controller if unauthorized modifications have been made.



### WARNING

**Failure to perform a safety check after the controller has been repaired can result in product damage or personal injury due to electrical shock or fire.**

If the controller has been repaired, before putting it back into operation, make sure qualified service personnel perform a safety check.

## 7.4 Error Codes and Possible Solutions

Table 7-1 lists failure symptoms and error codes, possible causes, and possible solutions.

*NOTE: Running the Controller diagnostics can possibly assist you in determining if the problem is with the 475 Controller or the Convector gauge.*

**Table 7-1 Failure Symptoms or Error Codes, Possible Causes, and Possible Solutions**

Symptom or Error Code	Possible Causes	Possible Solutions
The Controller will not power-up, no response to the power switch.	<ol style="list-style-type: none"> <li>1. Power interconnect cable improperly connected (see page 20).</li> <li>2. Over voltage, under voltage, or over current to the controller.</li> </ol>	<ol style="list-style-type: none"> <li>1. Check the power supply cable and power to the 475 Controller.</li> <li>2. Check the power to the Controller, which must be 12 to 24 Vdc, 6 W continuous.</li> </ol>
The displayed pressure reading is higher than expected.	<ol style="list-style-type: none"> <li>1. Poor gas conductance in gauge's vacuum connection to chamber, or a gas source in the plumbing to the gauge, such as a leak or contamination.</li> <li>2. The Convector gauge is mounted too far from the area of desired measurement. For example, the gauge could be mounted on a long adapter tube or chamber fitting that prevents the gauge from reading the actual pressure in the chamber.</li> <li>3. The Controller is out of calibration.</li> <li>4. Unknown gas type in the vacuum chamber</li> <li>5. The Convector gauge is not mounted horizontally.</li> <li>6. Extremes of temperatures or vibration of the Convector gauge.</li> <li>7. The sensor wire in the Convector gauge is damaged or contaminated.</li> </ol>	<ol style="list-style-type: none"> <li>1. Check the system for leaks and repair as required.</li> <li>2. Make sure the gauge is mounted close to the location where pressure measurement is desired.</li> <li>3. Recalibrate the Controller. See <i>Calibration</i> on page 48.</li> <li>4. Check the gas type being used and make sure the proper correction curves or settings are being used for that specific gas.</li> <li>5. Remount the gauge if necessary. See <i>Install the Convector Gauge</i> on page 18.</li> <li>6. Remount the gauge if necessary. See <i>Install the Convector Gauge</i> on page 18.</li> <li>7. Check and clean or replace the gauge. See <i>Convector Gauge Test Procedure</i> on page 81 and <i>Cleaning Contaminated Convector Gauges</i> on page 81.</li> </ol>
ERR 01 CGBAD	<ol style="list-style-type: none"> <li>1. The Convector gauge is either unplugged or defective. The reported pressure is 999T, and the relays are off.</li> <li>2. The Controller is out of Calibration.</li> </ol>	<ol style="list-style-type: none"> <li>1. Check the cable between the gauge and the Controller, and replace it if necessary. Check and clean or replace the gauge. See <i>Convector Gauge Test Procedure</i> on page 81 and <i>Cleaning Contaminated Convector Gauges</i> on page 81.</li> <li>2. Check the calibration and reset if necessary, See <i>Calibration</i> on page 48.</li> </ol>
ERR 09 NVRAM	<ol style="list-style-type: none"> <li>1. Not able to retrieve information from EEPROM.</li> </ol>	<ol style="list-style-type: none"> <li>1. Turn OFF, and turn ON power to the Controller.</li> </ol>
ERR 14 CABLE	<ol style="list-style-type: none"> <li>1. The cable is either unplugged or defective. The reported pressure is 999T, and the relays are off.</li> </ol>	<ol style="list-style-type: none"> <li>1. Check the cable between the gauge and the Controller, and replace it if necessary.</li> </ol>

**Table 7-1 Failure Symptoms or Error Codes, Possible Causes, and Possible Solutions**

Symptom or Error Code	Possible Causes	Possible Solutions
ERR 15 ADBAD	<ol style="list-style-type: none"> <li>1. The Analog/Digital Converter (A/D) is reporting an erroneous value.</li> <li>2. The reported pressure is 999T, and the relays are off.</li> </ol>	<ol style="list-style-type: none"> <li>1. Turn OFF, and turn ON power to the Controller.</li> <li>2. Check the calibration and reset if necessary, See <i>Calibration</i> on page 48.</li> </ol>
ERR 16 AOBAD	<ol style="list-style-type: none"> <li>1. The Analog Output is reporting an erroneous value.</li> <li>2. The micro controller A/D is damaged.</li> </ol>	<ol style="list-style-type: none"> <li>1. Turn OFF, and turn ON power to the Controller.</li> <li>2. Can still be used if the pressure reporting is still accurate.</li> </ol>
ERR 17 OVPRS	<ol style="list-style-type: none"> <li>1. The maximum pressure limit has been reached. The reported pressure is the maximum reported pressure for the gas species (999 Torr for N<sub>2</sub>).</li> <li>2. The gauge is contaminated or damaged.</li> <li>3. The controller is out of calibration.</li> </ol>	<ol style="list-style-type: none"> <li>1. Check to be sure that the actual pressure is within the range of the Controller. If it is, recalibrate the Controller or replace the gauge.</li> <li>2. Check and clean or replace the gauge. See <i>Convectron Gauge Test Procedure</i> on page 81 and <i>Cleaning Contaminated Convectron Gauges</i> on page 81.</li> <li>3. Check the calibration and reset if necessary, See <i>Calibration</i> on page 48.</li> </ol>
ERR 18 FAC	<ol style="list-style-type: none"> <li>1. CRC-16 checksum verification of factory settings has failed.</li> </ol>	<ol style="list-style-type: none"> <li>1. The Controller will automatically revert to the default values.</li> </ol>
ERR 19 FS	<ol style="list-style-type: none"> <li>1. CRC-16 checksum verification of "FS" curve has failed.</li> </ol>	<ol style="list-style-type: none"> <li>1. Revert to the N<sub>2</sub> or other gas curve.</li> </ol>

## 7.5 RS-232 Troubleshooting

See *RS-232 Troubleshooting* on page 72 in the chapter for the RS-232 interface.

## 7.6 Convectron Gauge Test Procedure

The small diameter sensor wire can be damaged by even small voltages. Do not perform electrical continuity tests with instruments applying in excess of 0.1 V when the gauge is at vacuum, or 2 V when at atmospheric pressure.

The Convectron gauge should show the resistances listed in Figure 7-1 (pin numbers are embossed on the gauge cable connector).

Figure 7-1 Convectron Gauge Pins



- Pins 1 to 2: 18 to 23 ohms
- Pins 2 to 3: 50 to 60 ohms
- Pins 1 to 5: 180 to 185 ohms

If the resistance from pins 1 to 2 reads about 800 ohms, the sensor wire in the gauge is broken. Replace the Convectron gauge.

*Note: If the resistance values shown here are correct, but you still think the gauge is not reading correctly, the gold plating on the tungsten sensor wire may be eroded and the gauge will have to be replaced.*

## 7.7 Cleaning Contaminated Convectron Gauges

When the small sensor wire in the Convectron gauge is contaminated with oil or other films, its emissivity or its diameter may be appreciably altered and a change of calibration will result.

### Baking to clean the gauge:

The Convectron gauge may be baked to 150 °C nonoperating while under vacuum with the cable disconnected. All materials used in the Convectron gauge are corrosion resistant, and bakeable to 150 °C.

### Chemically cleaning the gauge:

Cleaning with trichloroethylene, perchloroethylene, toluene, or acetone is possible but it must be done very carefully to not damage the sensor wire.

### WARNING

**Use of flammable solvents near open flame or energized electrical equipment can cause an explosion or fire.**

To avoid product damage or personal injury due to explosion or fire, use flammable solvents such as acetone and toluene only in a well-ventilated area that exhausts to the outdoors. Do not use such solvents near an open flame or energized electrical equipment.

**Exposure to fumes from solvents in an improperly ventilated area can cause personal injury.**

To avoid personal injury from inhaling fumes from solvents such as trichloroethylene, perchloroethylene, toluene, and acetone, use these solvents only in a well-ventilated area that exhausts to the outdoors.

Hold the gauge with the main body horizontal and the port projecting upward at an angle of 45 degrees. Slowly fill it with solvent using a standard wash bottle with the spout inserted in the port to the point where it touches the screen. Let the solvent stand in the gauge for at least ten minutes. **Do not shake the gauge.** Shaking the gauge with liquid inside can damage the sensor wire. To drain the gauge, position it horizontally with the port facing downward. Slightly warming the gauge will help dry the gauge. Allow the gauge to dry overnight with the port vertically downward and uncapped. Before re-installing the gauge on the system, be certain no solvent odor remains.

### 7.8 **Reset the Factory Defaults**

Follow the procedure below to return the controller to its factory default settings:

To reset VAC and ATM back to their original factory settings, turn OFF the Controller and hold the ENTER button while turning ON power to the controller. "Restore Factory Calibration" is displayed for approximately three seconds. The controller will then resume normal power-on operation.

### 7.9 **Returning a Damaged Controller**

If the Series 475 Convector Gauge Controller must be returned to the factory for service, request a Return Authorization (RA) from Brooks Automation / Granville-Phillips. Do not return products without first obtaining an RA. In some cases a hazardous materials document may be required. The Brooks Automation / Granville-Phillips Customer Service Representative will advise you if the hazardous materials document is required.

When returning equipment to Brooks Automation / Granville-Phillips, be sure to package the products to prevent shipping damage. Circuit boards and modules separated from the controller chassis must be handled using proper anti-static protection methods and must be packaged in anti-static packaging. Brooks Automation / Granville-Phillips will supply return packaging materials at no charge upon request. Shipping damage on returned products as a result of inadequate packaging is the Buyer's responsibility.

To obtain a Return Authorization (RA) number, contact Granville-Phillips Customer Service at:

- Phone **+1-303-652-4400** or **+1-800-776-6543**, 8:00 AM to 5:00 PM Mountain Time Zone weekdays, excluding holidays within the USA.
- Phone **+1-800-367-GUTS (+1-800-367-4887)** 24 hours per day, seven days per week within the USA.
- Email *co-csr@brooks.com*

## 7.10 Specifications

**Table 7-2 Specifications for the Series 475 Convectron Controller and 275 Convectron Gauges**

Measurement Range for N <sub>2</sub> / Air <sup>1,2</sup>	See notes 1 and 2, below
Torr	1x10 <sup>-4</sup> to 1000 Torr
mbar	1x10 <sup>-4</sup> to 1333 mbar
pascal	1x10 <sup>-2</sup> to 133.3 kpa
Resolution	1x10 <sup>-4</sup> Torr, 1x10 <sup>-4</sup> mbar, 1x10 <sup>-2</sup> Pascal
Display	Vacuum Fluorescent
Update rate	Every 0.5 sec.
Input power <sup>3</sup>	12 to 24 Vdc, 6 W continuous (Inrush <1.4A for <7 msec) (see note 3, below)
Weight	720 gr. (25 oz.)
Operating environment	0 °C to 40 °C ambient, non-condensing, indoor use only, ordinary protection from moisture, maximum altitude 3000 meters
Operating conditions	Suitable for continuous operation, category 1 for insulation overvoltage, pollution degree 2, Class 1
Non-operating temperature	-40 °C to 85 °C
CE Compliance	
EMC	EMC directive 2004/104/EC, EN61326-1
Safety	Low voltage directive EN61010-1
Environmental	RoHS compliant
Setpoint relays (Optional)	(2) single-pole, double-throw (SPDT) (Limit overvoltage to <2.4kv)
Contact rating	5 A @ 250 VAC resistive load
Range	1x10 <sup>-4</sup> to 1000 Torr, 0.1 to 1333 mbar, 0.01 to 133.3 kPa
Resolution	1 significant digit in the 10 <sup>-4</sup> range 2 significant digits in the 10 <sup>-3</sup> range 3 significant digits in the 10 <sup>-2</sup> range and above
Communication Interface (Optional)	
RS-232	
Data format	ASCII, 8/7 data bits, odd/even/no parity, one stop bit (the default is 8N1), selectable hardware handshake
Baud rate	1200, 2400, 4800, 9600, 19200, 38400 (19200 default)
Convectron Gauge	
Sensor material	Gold-plated tungsten, platinum
Other materials exposed to gas	304 stainless steel, borosilicate glass, Kovar, alumina, NiFe alloy, polyimide
Internal volume	40 cm <sup>3</sup> (2.5 in. <sup>3</sup> )
Weight	85 gm (3 oz.)
Mounting orientation	Horizontal preferred
Gauge operating temperature	0 °C to 50 °C ambient, non-condensing
Gauge bakeout temperature	150 °C maximum, non-operating, cable disconnected
Cable bakeout temperature	105 °C maximum

1. Measurements will change with different gases and mixtures. Correction parameters must be used for gases other than N<sub>2</sub> or Air.

2. Do NOT use Convectron gauges with flammable or explosive gases.

3. The 24 Vdc input power must be supplied from a power supply certified to IEC Standard with a safety extra low voltage certified output.

NOTES:

- A**  
 Analog Output  
   From Convectron Gauge **50**  
   Scaling **52**
- B**  
 Before You Begin  
   Caution and Warning Statements **9**  
   Customer Service **11**  
   Damage Requiring Service **11**  
   Reading and Following Instructions **9**  
 Button Overview **25**
- C**  
 Calibrate  
   How To **28**  
 Calibration  
   Atmosphere **48**  
   NIST Traceable **49**  
   Preparing for Operation **48**  
   Vacuum **48**  
 Caution and Warning Statements **9**  
 Chapters  
   Installation **13**  
   Preparing for Operation **25**  
   Process Control **53**  
   RS-232 Interface **57**  
   Safety Instructions **9**  
   Service and Maintenance **73, 77**  
 Command Syntax  
   RS-232 **61**  
 Command-Response Timing  
   RS-232 **59**  
 Controller  
   Error Codes **36**  
   Factory Defaults **14**  
   Specifications **83**  
 Convectron Gauge  
   Analog Output Signal **50**  
   Cleaning **81**  
   Installation **18**  
   Preparing for Operation **37**  
   Simulator **75**  
   Specifications **83**  
   Test Procedure **81**  
   Theory of Operation **37**  
 Customer Service **11, 77**
- D**  
 Damage Requiring Service **11, 77**  
 Default Settings **82**  
 Diagnostics **73**  
   How to **27**  
 Display  
   Setpoints **54**
- E**  
 Error Codes  
   Controller **36**  
   Troubleshooting **79**
- F**  
 Factory Defaults  
   Controller **14**  
 Figures  
   vacuum chamber ground connections **20**  
 Flowchart  
   Menu **26**
- G**  
 Gases  
   Other than N2 or Air **38**
- I**  
 Initial Power Up **25**  
 Installation  
   Configure the Relays **23**  
   Connect the Wiring **20**  
   Convectron Gauge **18**  
   Mount the Controller **16**  
   Pre-Installation Considerations **15**  
   Pressure Relief Devices **16**  
   Requirements for Process Control Option **23**  
   System Components **13**  
   Vacuum Chamber Fittings **19**
- M**  
 Menu  
   Flowchart **26**  
   Overview **26**
- O**  
 Overview  
   buttons **25**

**P**

- Power Up
  - Initial **25**
- Preparing for Operation
  - Analog Output Scale **52**
  - Button Overview **25**
  - Calibration **48**
  - Convectron Gauge **37**
  - Convectron Gauge Analog Output **50**
  - Pressure Measurement **25**
- Preparing RS-232 **60**
- Pressure Relief Devices **16**
- Process Control
  - Connecting Relays **54**
  - Requirements **23**
  - Setpoint Display and Adjustment **54**
  - Settings **55**
  - Setup **53**

**R**

- Reading and Following Instructions **9**
- Relays
  - Configuring for Application **23**
  - Connecting **54**
  - Setpoint Display and Adjustment **54**
- Returning a Damaged Controller **82**
- RS-232
  - Command Syntax **61**
  - Command-Response Timing **59**
  - Handshake **58**
  - Preparing **60**
  - Reset to Factory Defaults **63**
  - Theory of Operation **57**
  - Troubleshooting **72, 80**
  - User Commands, List of **61**
  - Wiring **57**

**S**

- Service and Maintenance
  - Convectron Gauge Test Procedure **81**
  - Customer Service **77**
  - Damage Requiring Service **77**
  - Factory Default Settings **82**
  - Returning a Damaged Controller **82**
  - Service Guidelines **77**
- Service Guidelines **77**
- Settings
  - Factory Default **82**
- Settings for Process Control **55**
- Simulator
  - Convectron Gauge **75**
- Specifications
  - Controller **83**
  - Convectron Gauge **83**

System Components

- Installation **13**
- System Menu
  - Flowchart **26**

**T**

- Theory of Operation
  - Convectron Gauge **37**
  - Convectron Gauge Simulator **75**
  - RS-232 **57**
- Troubleshooting
  - Error Codes **79**
  - RS-232 **72, 80**

**U**

- User Commands
  - RS-232 **61**

**W**

- Wiring
  - RS-232 **57**



## Series 475

# Granville-Phillips<sup>®</sup> Series 475 Convectron<sup>®</sup> Vacuum Measurement Controller



**6450 Dry Creek Parkway**  
Longmont, CO 80503 USA  
Phone: +1-303-652-4400

**15 Elizabeth Drive**  
Chelmsford, MA 01824 USA  
Phone: +1-978-262-2400

Worldwide Customer Service/Support - 24/7  
Phone: +1-800-367-4887

To obtain a copy of this instruction manual online,  
visit our website at [www.brooks.com](http://www.brooks.com)

(Adobe<sup>®</sup> Reader<sup>®</sup> version 5.0 or higher required)

© 2009 Brooks Automation, Inc.

## Instruction Manual

*Instruction manual part number 475101*

*Revision A - November 2009*