

VACUUM EQUIPMENT

GENERAL CATALOG

A large, grayscale, 3D-rendered spiral graphic that dominates the center of the page. It consists of multiple concentric, slightly offset rings that create a sense of depth and rotation, resembling a vacuum chamber or a turbine component.

The Air of Trust

HISTORY OF ANEST IWATA SINCE 1993

1993

The world's first Oil-free Scroll Vacuum Pump was launched (ISP-500)



2007

Largest pumping displacement model in the ISP series was launched (ISP-1000)



1997

A robust single-wrap scroll vacuum pump was introduced to the market (DVSL-500)



ANEST IWATA has been the leader in the dry scroll technology since 1993 as we were the first to develop the air-cooled, oil-free scroll-type vacuum pump. We continue to strive in the DRY SCROLL technology with a pump that is more compact, has less vibration, and quieter than other dry vacuum pumps.

2011 |

The DVSL hard coated unit was announced

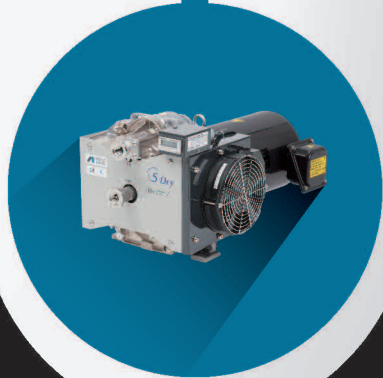

| 2008

The GVS series was introduced as the affordable single wrap scroll

| 2016

The DVSL-500 model was introduced with a high-efficiency three phase motor



VACUUM EQUIPMENT LINE UP

ANEST IWATA has a wide range line up of Vacuum pumps.

The performance of a vacuum pump is determined by its ultimate pressure and pumping speed. ANEST IWATA provides a wide variety of vacuum pumps, each with a different ultimate pressure and a different pumping speed so customers can select the products that suit their budget and needs.

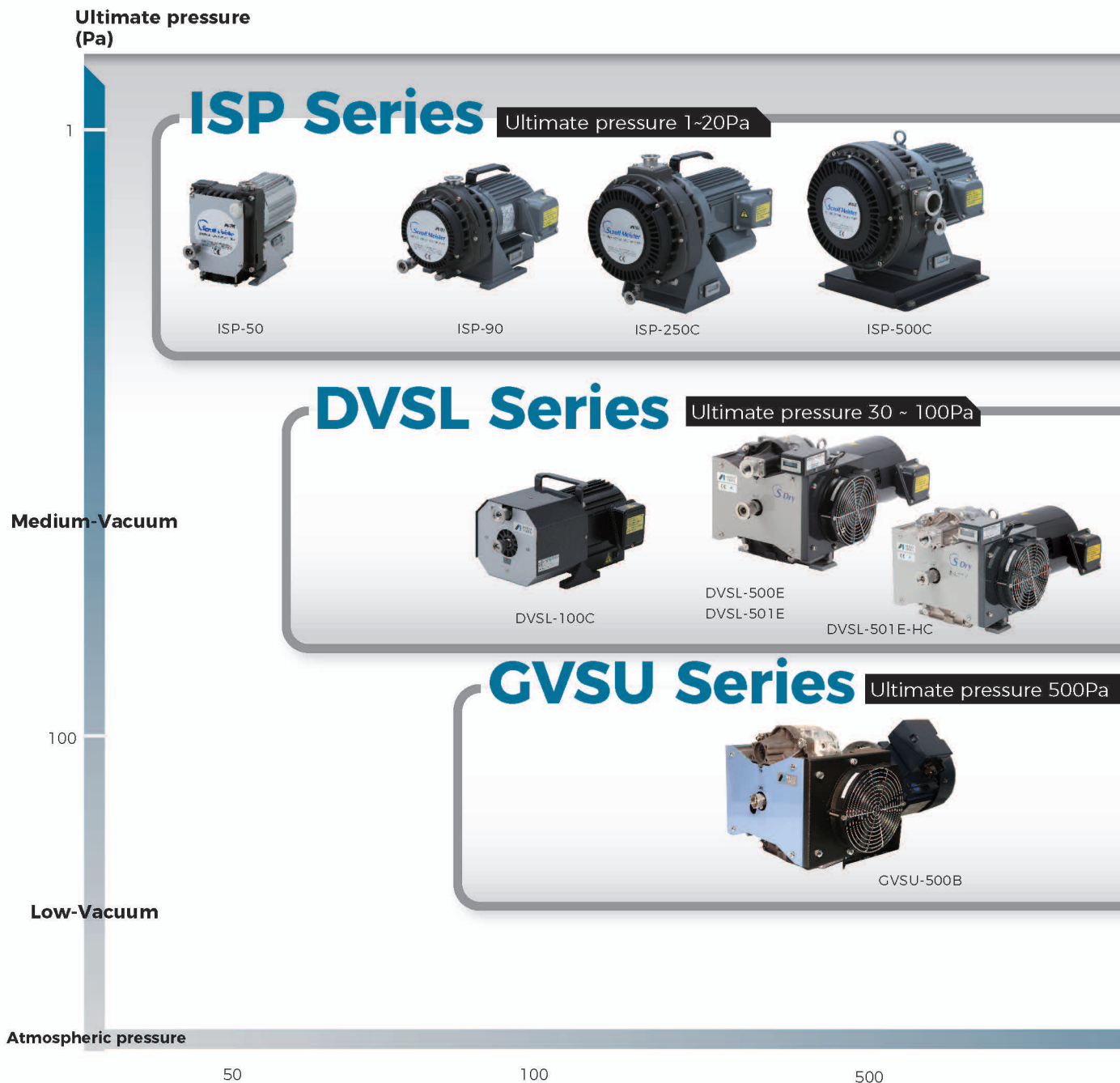

Features of ANEST IWATA Vacuum pump

Oil-Free

Conventional oil-sealed rotary pumps use oil for sealing. This can cause contamination in the air and/or stains on the floor from oil mist and back-migration of oil. ANEST IWATA was the first to develop an oil-free scroll pump in the world, which solves any issues with contamination and maintenance problems. The pump is used by many customers in a wide range of applications from cutting-edge industries in the field of physical and chemical science to general purpose uses.

Scroll

The scroll mechanism is the continuous processes of suction, compression and exhaust with little change in torque, resulting in low vibration and low noise. The suction chamber and exhaust chamber are not adjacent to each other, making the pump less prone to leaks and highly efficient.

Air cooling

The use of an air cooling system, instead of a water cooling system, eliminates the need for the burdensome job of maintaining cooling water and allowing the pump to be installed in places where it was formerly difficult to install. Another feature of ANEST IWATA's vacuum pump is that they are light and compact and designed to minimize the installation space.



ISP-1000E

ISP series

The ISP Series consists of models supporting medium-vacuum pressures of 1 to 15 Pa and pumping speeds of 50 to 1000 L/min. The pumps are designed with focus on performance, and boast an excellent track record in both cutting-edge industries and general-purpose applications. Applications: See pages 9-10

DVSL series

DVSL pumps are ideal for low to mid vacuum applications. There are 4 models with pumping speeds from 100L/min to 500L/min. Our HC version provides higher durability for demanding applications. Applications: See page 14

GVSU series

GVSU pumps are ideal for low vacuum applications. We provide a model with a pumping speed of 500L/min and ultimate vacuum of 500Pa. Applications: See page 14

Principle of Compression

As the orbiting scroll rotates, shown in the illustration from the No.1 position to the No.4 position, crescent shaped air pockets are gradually reduced. At the last stage compressed air is exhausted through the center port.

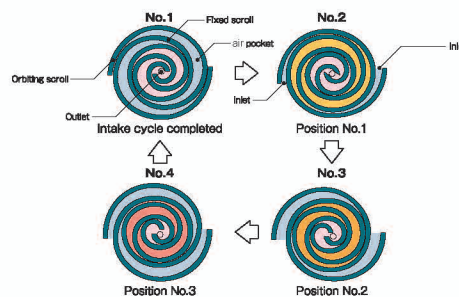

BEST SELLING MID VACUUM PUMPS

ISP Series

Our ISP scroll pumps work completely Oil-free, making them ideal for processes where a clean dry vacuum is needed. Our dual wrap scroll technology provides excellent flow rates for efficient pump down speeds and ultimate pressures.

The ISP vacuum pump series offers a wide range of pumping speeds that can accommodate many applications in the analytical, medical and laboratory fields.

The features and benefits of the ISP vacuum pumps are :

- Energy efficient
- Quiet
- Low vibration
- Longer maintenance cycle



ISP-1000E



ISP-500C



ISP-250C



ISP-90



ISP-50

How to select for ISP series

ISP-○○-●●

Design Pumping Speed of vacuum pump

T: Three phase motor S: Single phase motor

V: Vertical inlet H: Horizontal inlet

- Selectable items are different from models.

SPECIFICATIONS

Model			ISP-50	ISP-90	ISP-250C	ISP-500C	ISP-1000E
Pumping Speed	50Hz	L/min (CFM)	50 (1.8)	90 (3.2)	250 (8.8)	500 (17.7)	1000 (35.3)
	60Hz		60 (2.1)	108 (3.8)	300 (10.6)	600 (21.2)	1200 (42.4)
Ultimate pressure		Pa (Torr)	15 (1.1x10 ⁻¹)	5 (3.7x10 ⁻²)	1.6 (1.2x10 ⁻²)	1.0 (7.5x10 ⁻³)	1.0 (7.5x10 ⁻³)
Motor output		kW	0.1	0.15	0.4	0.6	1.4
Voltage	Single phase	V	100, 115, 200, 230				-
	Three phase		-	200, 208, 230, 380, 400, 415, 460			
Noise level		dB(A)	48	52	58	62	68
Leak tightness		Pa · m3/s	1.0x10 ⁻⁷	1.0x10 ⁻⁵			
Ambient temperature		°C (°F)	5 to 40 (41 to 104)				10 to 40 (50 to 104)
Weight	Single phase	kg (lbs)	12 (27)	14 (31)	25 (55)	44 (97)	-
	Three phase		-	23 (51)	38 (84)	68 (150)	
Water vapor capacity		g/day	3	5	25	25	25
Inlet connection		-	NW25			NW40	
Outlet connection		-	NW16			NW25	NW40
Inlet position		Vertical	✓	✓	✓	✓	✓
		Horizontal	-	-	-	✓	✓
Standards							

All pumps come standard with air flush attachment and hour meter

All single phase pumps come standard with thermal protection

AIR FLUSH

Pumping humid gas with a vacuum pump can cause condensed moisture to remain in the pump. This remaining moisture can affect the ultimate pressure as well as cause the pump to fail. In order to extend the life of the pump, we recommend utilizing the air flush to remove any moisture.



BEST SELLING MID VACUUM PUMPS

ISP Series

DIMENSIONS & PUMPING SPEEDS

ISP-50

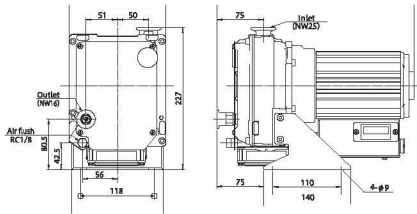

L317 x W155 x H227 mm

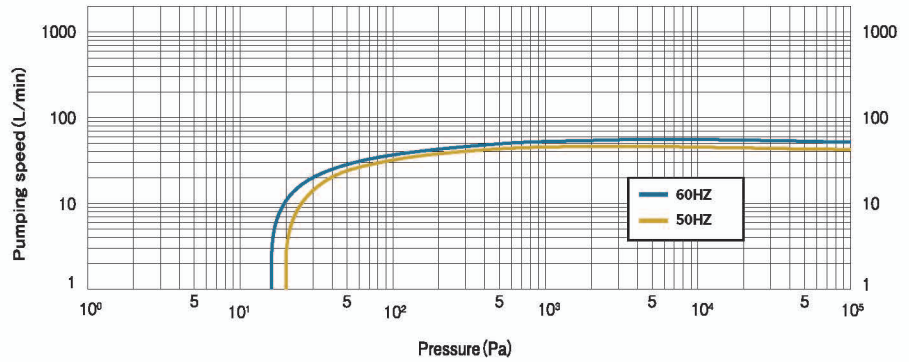

ISP-90

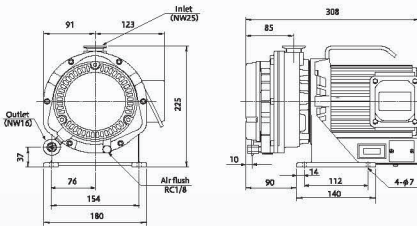

L308 x W214 x H225 mm

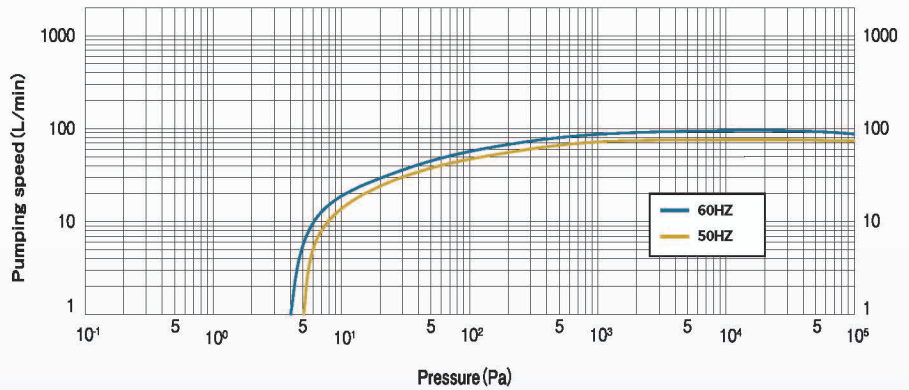

ISP-250C-SV

ISP-250C-TV

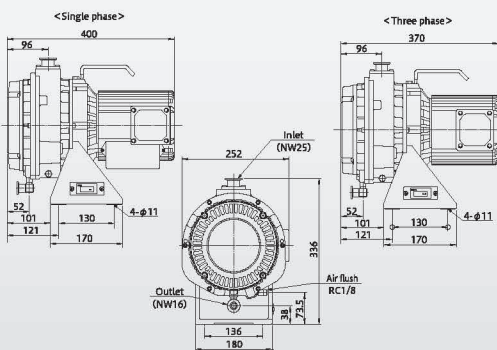

<Single phase>
L400 x W252 x H336 mm

<Three phase>
L370 x W252 x H336 mm

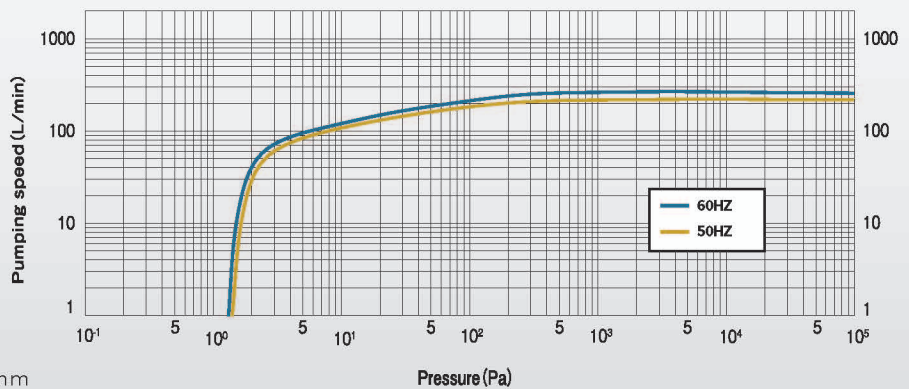

ISP-500C-SV, SH

ISP-500C-TV, TH

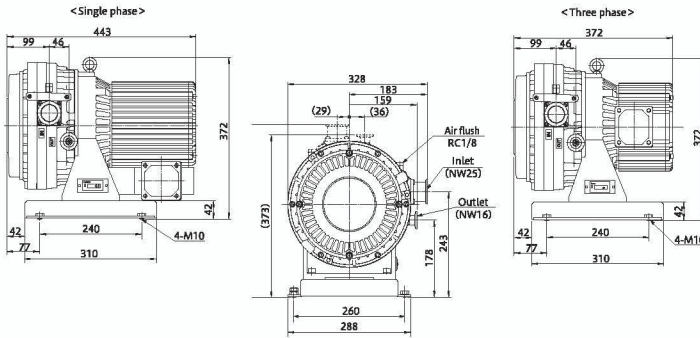

<Single phase>
Vertical : L443 x W304 x H397
Horizontal : L443 x W328 x H372

<Three phase>
Vertical : L372 x W304 x H397
Horizontal : L372 x W328 x H372

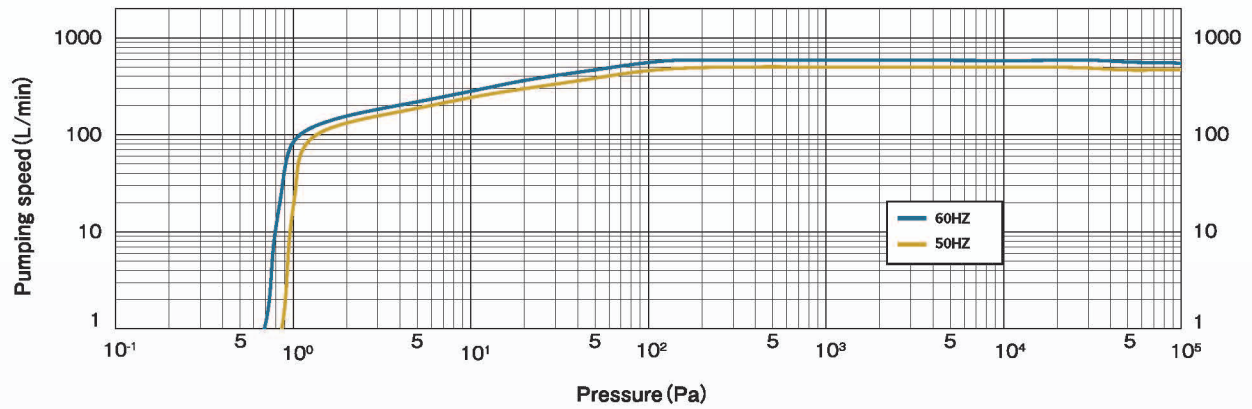

ISP-1000E-TV, TH

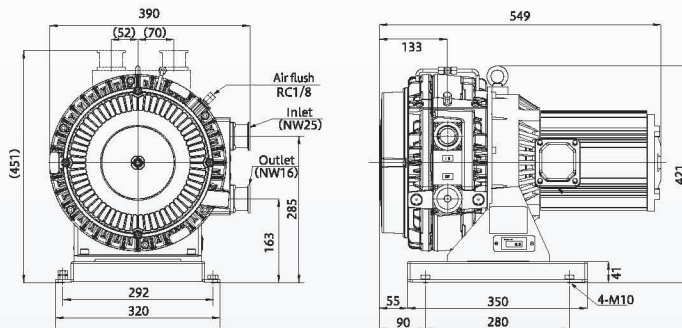

Vertical : L549 x W359 x H451
Horizontal : L549 x W390 x H421

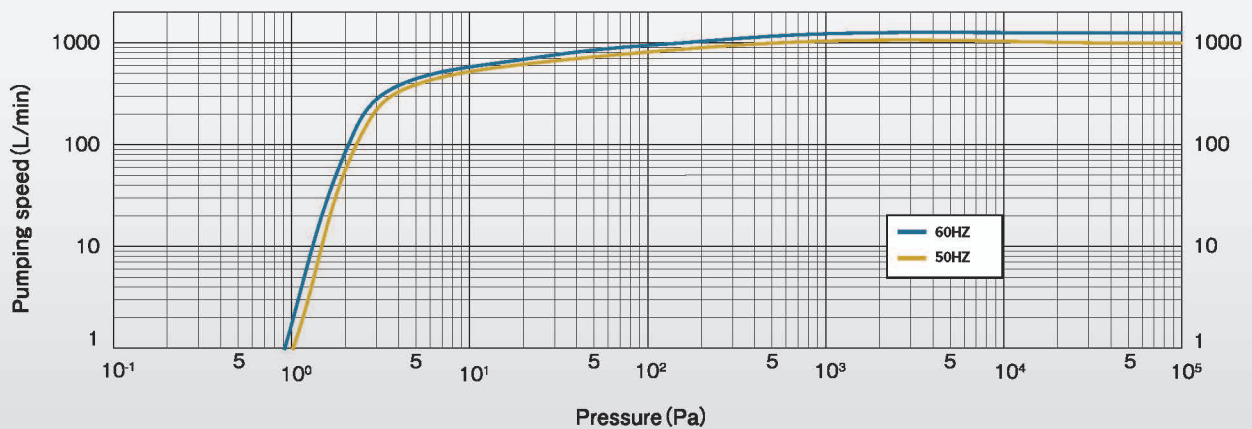

BEST SELLING MID VACUUM PUMPS

ISP Series

APPLICATIONS

As the original developer in the dry scroll technology, the ISP vacuum pumps offer a wide range of pumping speeds and ultimate pressure that are used in many applications in the research and development and production areas.

Below are some common applications where the ISP vacuum pump can be used.

01 Accelerator Synchrotron

Vacuum is required to keep electrons and photons from being slowed down by colliding with atoms and molecules.



02 Leak Detectors

Checking leakage by measuring pressure change overtime while under vacuum. Leak tight pump is needed for Helium leak tester to prevent the influence of background.

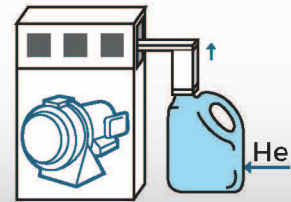

03 Electron Microscope

Electron microscopes use scattered electrons and transmitted electrons to measure surface conditions and internal conditions under vacuum.

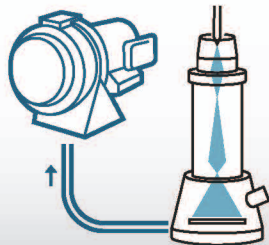

04 Mass Spectrometry

Measures the mass of a molecule. Utilizes vacuum to convert the molecule to a gas-phase ion.



05 Sputtering

Involves ejecting material from a source "target" onto a "substrate".

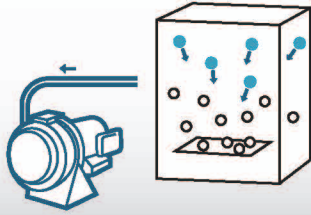

06 Evaporation Deposition

Coating source material is evaporated in a vacuum. This allows vapor particles to travel directly to the "substrate" where they condense back to a solid state.

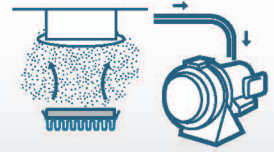

07 Vacuum Sterilizer

Utilizes a series of sterilizing gas injections and evacuations with a vacuum system.

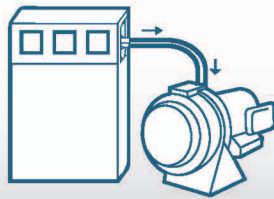

08 Vacuum Freeze Drying

Pressure is lowered to create ice sublimation. Vacuum speeds up the sublimation.

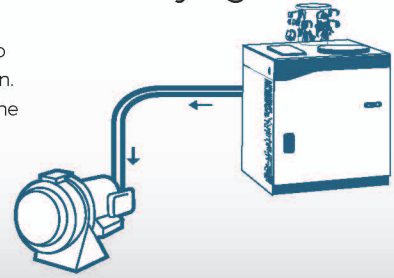

09 Vacuum Heat Treatment

Preventing oxidation and removing absorbed gases for heat treatment under vacuum.

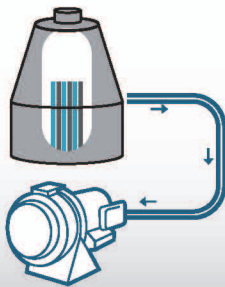

10 Cryogenics

Vacuum pumps are used in conjunction with Cryo pumps for chamber evacuation and gas regeneration.

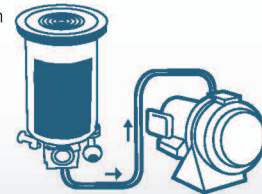

** Please consult factory or authorized distributor for application review **

BEST SELLING LOW VACUUM PUMPS

DVSL/GVSU Series

Our DVSL/GVSU scroll pump line offers a dry, clean and reliable vacuum pump for general industrial applications. They provide a superior alternative to dry vane and oil-flooded rotary vane pumps.

The features and benefits of the DVSL/GVSU vacuum pumps are :

- Excellent for displacing water vapor
- Deep ultimate pressure
- Reduced maintenance cost
- Helps keep installation area clean

GVSU-500B



DVSL-501E-HC



DVSL-500E



DVSL-501E



DVSL-100C



SPECIFICATIONS

Model			DVSL-100C	DVSL-500E	DVSL-501E	DVSL-501E-HC	GVSU-500B
Pumping speed	50Hz	L/min (CFM)	100 (3.5)	433 (15.4)			-
	60Hz		120 (4.3)	516 (18.3)			522 (18.5)
Ultimate pressure		Pa (Torr)	50 (3.8x10 ⁻¹)	30 (2.6x10 ⁻¹)	100 (7.5x10 ⁻¹)		500 (3.8)
Motor output		kW	0.3	0.9 / 1.1			1.5
Voltage	Single phase	V	100, 115 200, 230	-			
	Three phase		-	200, 220, 230, 380, 400, 415, 460			230, 460
Noise level		dB(A)	62	64			
Ambient temperature		°C (°F)	5 - 40 (41 - 104)				
Weight		kg (lbs)	15 (33)	34 (75)			37 (82)
Water vapor capacity		g/day	100	250			
Inlet connection			NW25 with Rc 3/8	NW25 with Rc1/2			Rc1
Outlet connection			NW16	NW25			Rc1/2
Standards							UL Certified motor 

All pumps come standard with air flush attachment
 DVSL-100C comes standard with thermal protection
 GVSU-500B is only available in North America
 GVSU-500B comes standard with water separator silencer

Features of the DVSL-501E-HC

The new DVSL-501E-HC pump has a special coating that extends the life of the scroll surface up to 3 times longer. * It can handle certain chemical applications better than the regular DVSL.

* This value can change depending on customer's application



BEST SELLING LOW VACUUM PUMPS

DVSL/GVSU Series

DIMENSIONS & PUMPING SPEEDS

DVSL-100C

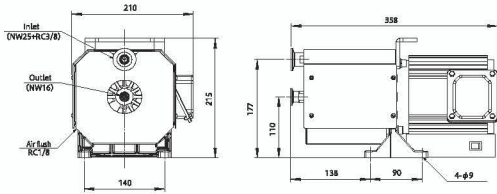

L358 x W210 x H215 mm

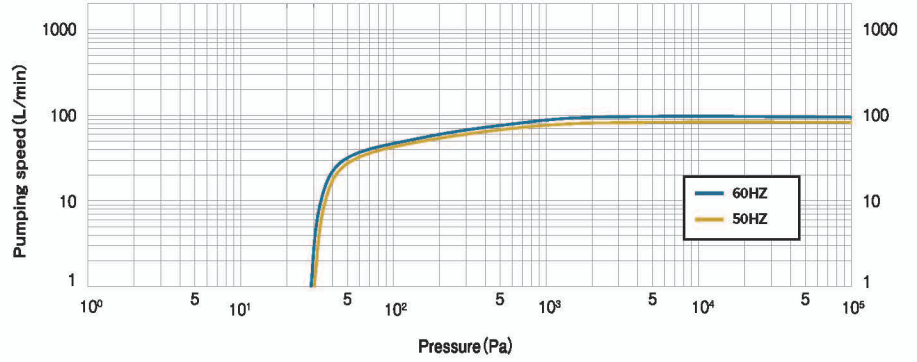

DVSL-500E/501E

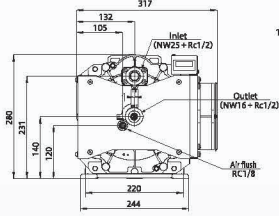

L521 x W317 x H280 mm

DVSL-501E-HC

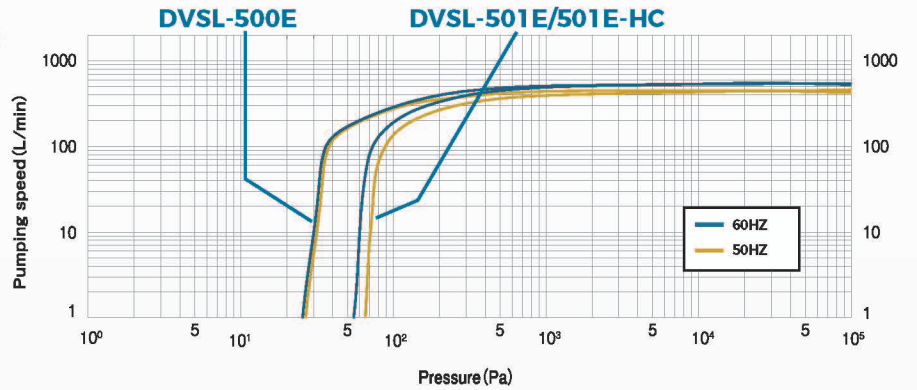
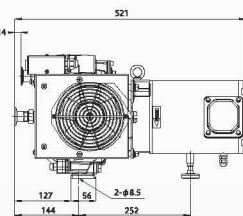

GVSU-500B

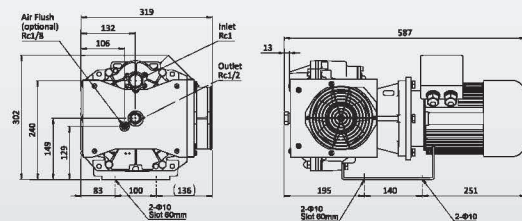

L566 x W317 x H280 mm

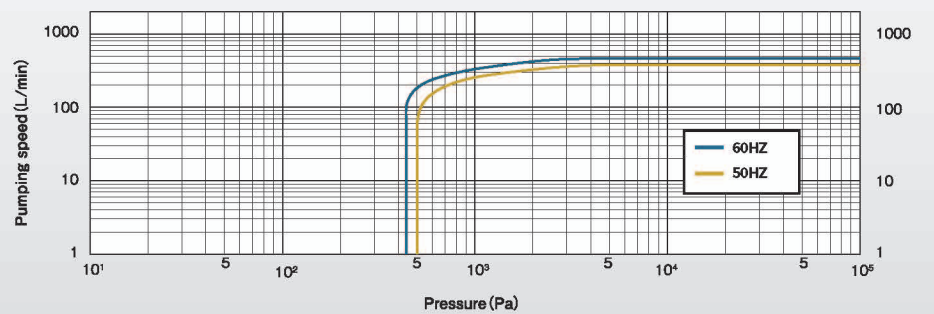

DVSL/GVSU Series

■ APPLICATIONS

The DVSL/GVSU scroll vacuum pumps are easy to maintain and require no lubricating oil. The dry design is very reliable, clean and allows for continuous operation between atmospheric and ultimate pressure. The pumps are engineered to handle and displace large amounts of water vapor through the air flush.

Below are some of the common applications for the DVSL/GVSU.

01 Pick and Place

Pick and Place machines use dry scroll technology to ensure that no contamination migrates into the process and packaging.

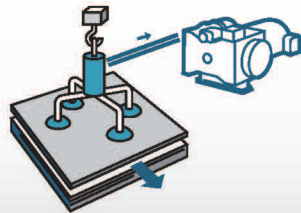

02 Degassing

Degassing applications need reliable and robust pumps to handle high vapor loads while also providing the highest hygiene standard for food processing.

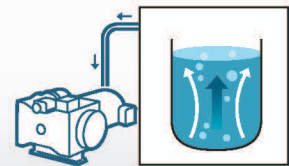

03 Vacuum Forming

A consistent, reliable scroll pump can help eliminate knit lines caused by gas or air entrapment.

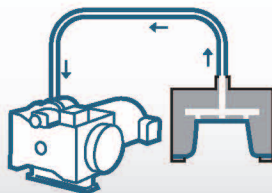

04 Vacuum Filling

Product quality and faster fill times can be achieved with a dry vacuum pump.

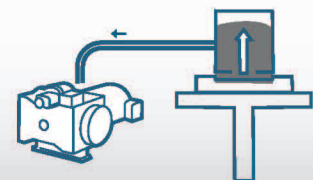

05 Vacuum Packaging

The removal of air from a package or container prior to sealing creates a clean product for medical and retail use.

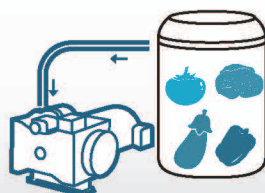

06 Vacuum Drying

During product processing, moisture can be removed by our air flush and allow for a more consistent product.

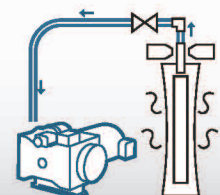

** Please consult factory or authorized distributor for application review **

PARTS

ISP Series

	ISP-50	ISP-90	ISP-250C	ISP-500C	ISP-1000E
MODULE ONLY	NA	VSD-90	VSD-250C	VSD-500C	VSD-1000E
MAJOR SERVICE KIT	98888240	98882590	98883251	98882251	98882830
MINOR SERVICE KIT	NA	98881590	98884250	98881250	98881830
CRANK SHAFT	98889230	98885580	98882260	98883230	98885820
PIN CRANK KIT	98883580	98883580	98883131	98885230	98884810

ISP Major Kit includes: Tip Seal set, Bearing set, Seal set, O-ring, Exhaust Valve set, Grease kit and Air Flush kit

ISP Minor Kit includes: Seal set, O-ring set, Exhaust Valve set, Grease kit and Air Flush kit

Tool Kit must be used for any major or minor repairs

Additional service parts are available

DVSL/GVSU Series

	DVSL-100C	DVSL-500E	DVSL-501E	DVSL-501E-HC	GVSU-500B
MODULE ONLY	NA	DVS-500E	DVS-501E	NA	GV-165B-F
SERVICE KIT	98889150	98882951	98881930	98881930	NA
SEAL SET	98890150	98881940	98882930	98882930	98881940
FS SET	98815232	98885940	98885940	NA	98885940
OS SET	98816231	98880950	98880950	NA	98880950

DVSL/GVSU Service Kit includes: Seal set, Air Flush kit and Exhaust valve kit

DVSL/GVSU Seal Set includes: Tip Seal kit, P-seal, O-ring and Coupling spider

Tool Kit must be used for any repairs

Additional service parts are available

Tip Seal



Crank Shaft



Pin Cranks



ACCESSORIES

ISP Series

Name	Parts No.	Model	Description
Power Supply Cable	610010	ISP-90, 250C, 500C	AWG14 115V Single phase
Power Supply Cable	610020	ISP-90, 250C, 500C	AWG14 300V Single phase No plug
Exhaust Silencer	610060	ISP-90, 250C	NW16
Exhaust Silencer	600080	ISP-500C	NW25
Isolation Valve	550130	ISP-50, 90, 250C	120V 60Hz NW25
Isolation Valve	550140	ISP-50, 90, 250C	208V 60Hz NW25
Isolation Valve	550150	ISP-50, 90, 250C	220V 50/60Hz NW25
Isolation Valve	550160	ISP-500C, 1000E	120V 60Hz NW40
Isolation Valve	550170	ISP-500C, 1000E	208V 60Hz NW40
Isolation Valve	550180	ISP-500C, 1000E	220V 50/60Hz NW40

DVSL/GVSU Series

Name	Parts No.	Model	Description
Inlet Filter	610090	GVSU-500B	Inlet : FPT 1", with connection piping
Exhaust Silencer	610100	DVSL-500E/501E/HC	R 1/2" with drain hose

Isolation Valve



Exhaust Silencer
(600080)



Exhaust Silencer
(610060)



ANEST IWATA Air Engineering

Company: ANEST IWATA Air Engineering Inc.
Address: 9525 Glades Dr. West Chester, Ohio 45069 U.S.A.
Phone: 513-755-5130
Toll Free: 800-440-0282
Fax: 513-755-1889
Email: vacuuminquiry@anestiwata.com
Website: www.anestiwata.com
Line of Business: Manufacture and sale of Air compressors, Pneumatic equipment, and Air driven equipment.
Manufacture and sale of Vacuum equipment and systems.

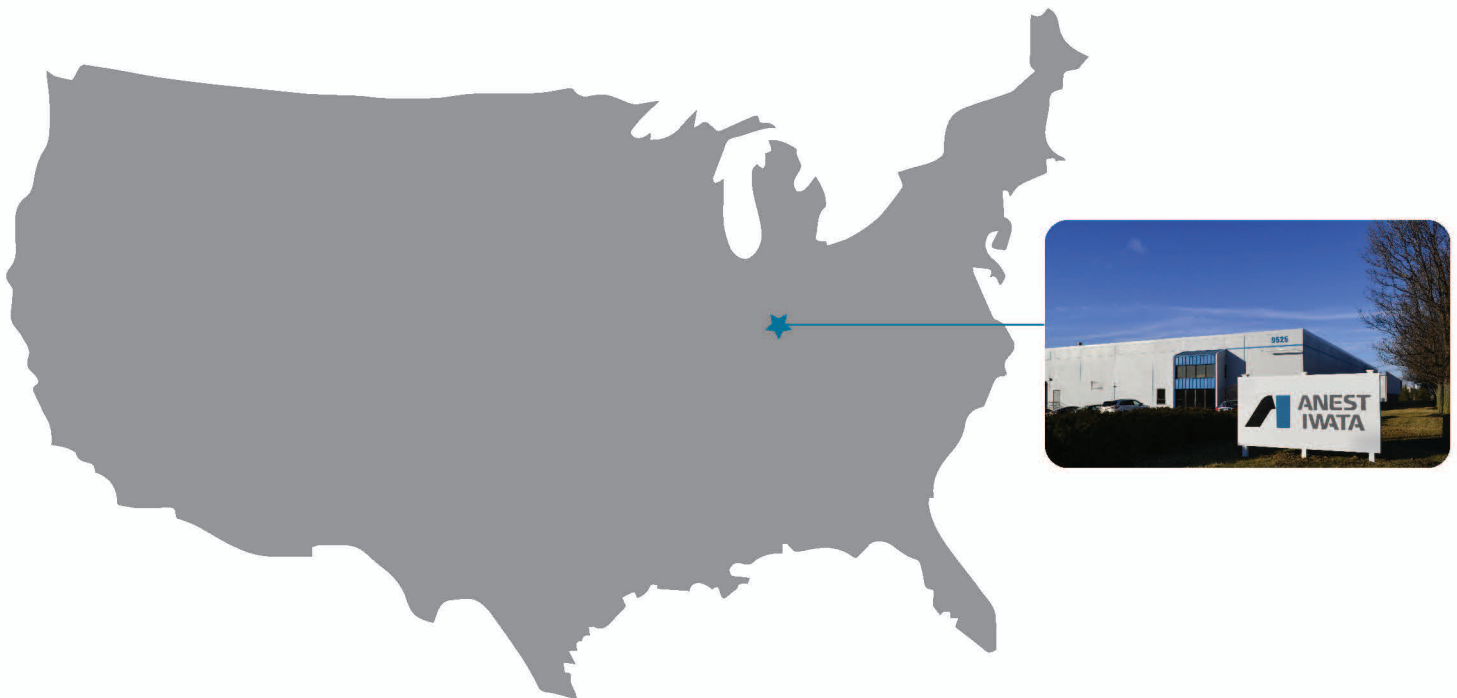

Precaution on usage

- This vacuum pump is suitable for clean processes only.
- Do not use explosive, flammable, toxic or corrosive substances or substances which contains chemicals, solvents or particulates.
- ANEST IWATA will not perform maintenance work on pumps which have used hazardous substances.
- The thermal protector installed on a single phase motor will automatically reset after the motor has cooled down. Be sure to install overcurrent protective device.
- Do not alter or disassemble the product.
- Be sure to read instruction manual and understand it fully before use.
- The warranty period is based on instruction manual. Maintenance interval and the warranty period are different.
- Classification which is based on Foreign Exchange and Foreign Trade Control Act is necessary for export. Please contact us.

Caution for installation

- Install in an area which is not exposed to explosives, flammable gas, or other related things.
- Pumps do not have overcurrent protective device for burnout. Install overcurrent protective device properly for safety.
- Electric source cable is not included in the pump. Use electric source cable which is instructed by instruction manual.
- Periodic maintenance is required. Please install it in a location that can be maintained and ventilated.
- The specifications in the catalogue is measured by our company standards. There is no guarantee on your conditions and applications.
- When you start and stop the pump repeatedly, it may shorten life of the product. Please contact us if you like detailed information.
- Models, specifications and photos are subject to change without notice.

Global Network

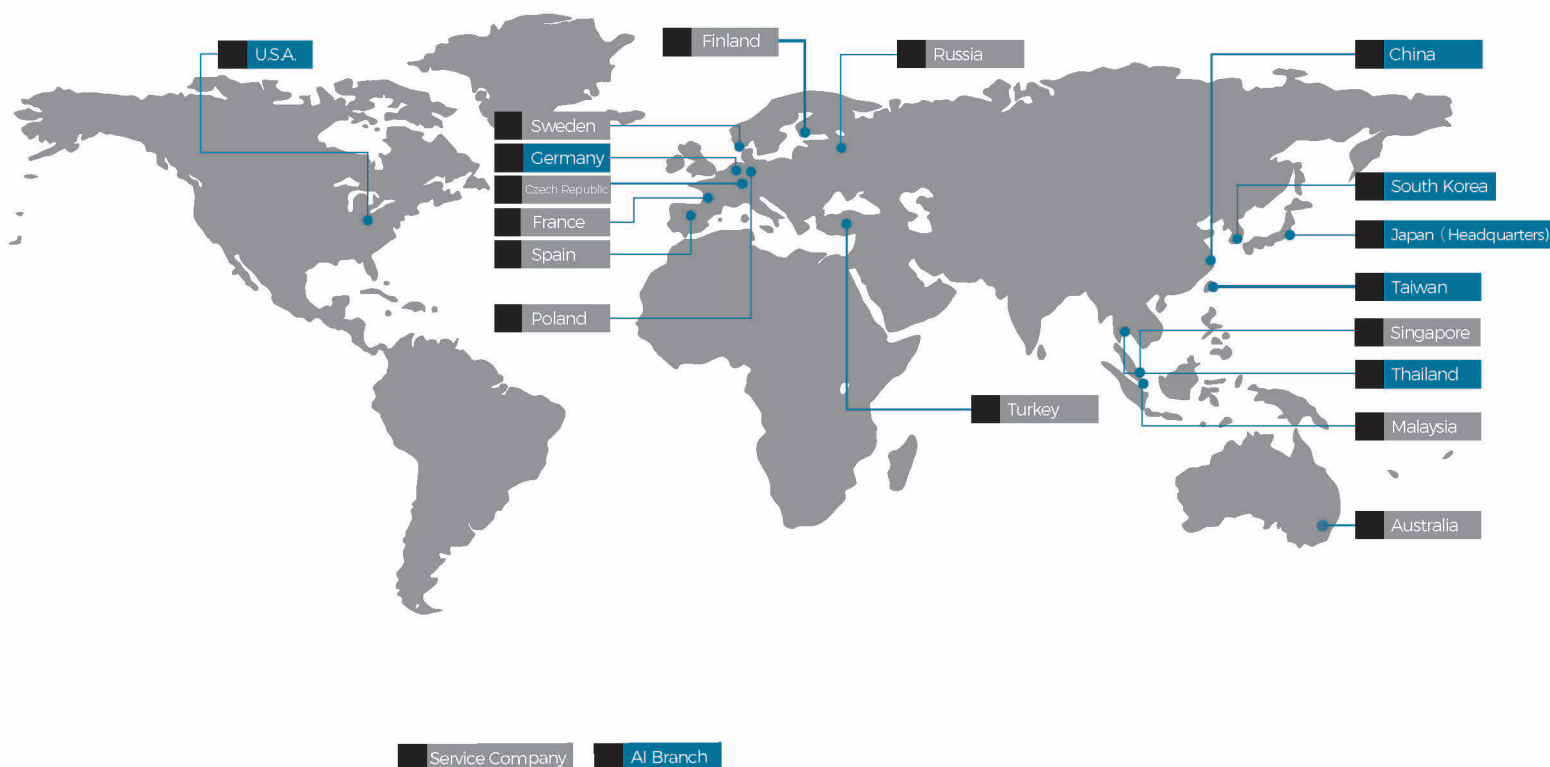

AI Branch
Service Company

Japan, China, South Korea, Taiwan, Thailand, Germany, USA
Singapore, Malaysia, Australia, Russia, Sweden, France, Netherland, Spain, Poland, Czech Republic, Turkey, Finland

ANEST IWATA Headquarters

Company: ANEST IWATA Corporation
Address: 3176 Shinyoshida-cho, Kohoku-ku, Yokohama 223-8501 Japan
Line of Business: Vacuum pumps, Air compressors, Coating equipment and coating system.

Phone: +81 (0) 45-591-1112
Fax: +81 (0) 45-593-1539
Website: <http://www.anest-iwata.co.jp/>



Company: ANEST IWATA Air Engineering Inc.
Address: 9525 Glades Dr.
West Chester, Ohio 45069 U.S.A.
Phone: 513-755-5130
Toll Free: 800-440-0282
Fax: 513-755-1889
Email: vacuuminquiry@anestiwata.com
Website: www.anestiwata.com