



OPERATING INSTRUCTIONS

EN

Translation of the Original

DCU 002 | 110 | 180 | 310 | 400
Display Control Unit

PFEIFFER  **VACUUM**

Customer,

Thank you for choosing a Pfeiffer Vacuum product. Your new Display Control Unit should support you in your individual application with full performance and without malfunctions. The name Pfeiffer Vacuum stands for high-quality vacuum technology, a comprehensive and complete range of top-quality products and first-class service. From this extensive, practical experience we have gained a large volume of information that can contribute to efficient deployment and to your personal safety.

In the knowledge that our product must avoid consuming work output, we trust that our product can offer you a solution that supports you in the effective and trouble-free implementation of your individual application.

Please read these operating instructions before putting your product into operation for the first time. If you have any questions or suggestions, please feel free to contact info@pfeiffer-vacuum.de.

Further operating instructions from Pfeiffer Vacuum can be found in the [Download Center](#) on our website.

Disclaimer of liability

These operating instructions describe all models and variants of your product. Note that your product may not be equipped with all features described in this document. Pfeiffer Vacuum constantly adapts its products to the latest state of the art without prior notice. Please take into account that online operating instructions can deviate from the printed operating instructions supplied with your product.

Furthermore, Pfeiffer Vacuum assumes no responsibility or liability for damage resulting from the use of the product that contradicts its proper use or is explicitly defined as foreseeable misuse.

Copyright

This document is the intellectual property of Pfeiffer Vacuum and all contents of this document are protected by copyright. They may not be copied, altered, reproduced or published without the prior written permission of Pfeiffer Vacuum.

We reserve the right to make changes to the technical data and information in this document.

Table of contents

1	About this manual	7
1.1	Validity	7
	1.1.1 Applicable documents	7
	1.1.2 Variants	7
1.2	Target group	7
1.3	Conventions	7
	1.3.1 Instructions in the text	7
	1.3.2 Pictographs	8
	1.3.3 Stickers on the product	8
	1.3.4 Abbreviations	8
2	Safety	10
2.1	General safety instructions	10
2.2	Safety instructions	10
2.3	Safety precautions	12
2.4	Limits of use of the product	12
2.5	Proper use	12
2.6	Foreseeable misuse	12
3	Product description	13
3.1	Identifying the product	13
3.2	Product features	13
3.3	Shipment	13
3.4	Function	13
	3.4.1 Key functions	14
	3.4.2 Status symbols	15
4	Installation	17
4.1	Preparing for installation	17
4.2	Installing the device in a rack	17
4.3	Connecting the electrical supply	17
	4.3.1 Connection diagram	18
	4.3.2 Earthing the device	19
	4.3.3 Connect DCU to a vacuum pump	19
	4.3.4 Establishing mains connection	20
4.4	Connecting measuring tubes	21
5	Parameter set	22
5.1	General	22
5.2	Additional parameter for the DCU	22
5.3	Data types used	23
6	Operation	24
6.1	LC-display	24
6.2	Switching on the DCU	24
6.3	Displaying and configuring parameters with the DCU	25
6.4	Switching on the connected vacuum pump	26
6.5	Transmitter operation	26
6.6	Switching off the connected vacuum pump	26
6.7	Operating mode display via LED	27
6.8	Switching off the DCU	27
7	Maintenance	28
8	Malfunctions	29
8.1	General	29
8.2	Error codes	29

9	Service solutions from Pfeiffer Vacuum	30
10	Accessories	32
11	Technical data and dimensions	33
	11.1 Technical data	33
	11.2 Dimension drawings	34
	Declaration of conformity	35

List of tables

Tbl. 1:	Stickers on the product	8
Tbl. 2:	Abbreviations used in this document	9
Tbl. 3:	Permissible ambient conditions	12
Tbl. 4:	Product features	13
Tbl. 5:	Description of the key functions of the DCU	15
Tbl. 6:	Status symbols and display on the DCU	16
Tbl. 7:	Connection possibilities for electronic drive unit and transmitter	18
Tbl. 8:	Available Pfeiffer Vacuum transmitters for connection to a DCU	21
Tbl. 9:	Explanation and meaning of the parameters	22
Tbl. 10:	Parameter for DCU functions	23
Tbl. 11:	Meaning of functions and layout of the LC-display	24
Tbl. 12:	Self-test, internal requests after switching on	25
Tbl. 13:	Selecting and setting parameters	25
Tbl. 14:	Examples of displays for the transmitter	26
Tbl. 15:	Examples of displays for the actual pressure value	26
Tbl. 16:	LED display and meaning at the DCU	27
Tbl. 17:	Warning and error messages when using the DCU	29
Tbl. 18:	DCU 002	33
Tbl. 19:	DCU 110, DCU 180	33
Tbl. 20:	DCU 310, DCU 400	33

List of figures

Fig. 1:	Position of the labels on the product	8
Fig. 2:	DCU control panel, front view	13
Fig. 3:	DCU with integrated power supply pack, rear view	14
Fig. 4:	DCU 002, rear view	14
Fig. 5:	Connection diagram for the DCU with integrated power supply pack	18
Fig. 6:	Connection diagram for the DCU 002	18
Fig. 7:	Connection of the grounding cable to the DCU with integrated power supply pack	19
Fig. 8:	Example: Connection of a DCU 002 to a vacuum pump	20
Fig. 9:	Example: Connection of a DCU with integrated power supply pack to a vacuum pump	20
Fig. 10:	LC-display, overview	24
Fig. 11:	Dimensions DCU 002	34
Fig. 12:	Dimensions DCU 110	34
Fig. 13:	Dimensions DCU 180, DCU 310, DCU 400	34

1 About this manual



IMPORTANT

Read carefully before use.
Keep the manual for future consultation.

1.1 Validity

These operating instructions are for customers of Pfeiffer Vacuum. They describe the function of the designated product and provide the most important information for safe usage of the product. The descriptions comply with applicable directives. All information provided in these operating instructions refer to the current development status of the product. The documentation remains valid as long as the customer does not modify the product in any way.

1.1.1 Applicable documents

DCU Display Control Unit	Number
Declaration of conformity	Part of this document

1.1.2 Variants

This instruction applies for Display Control Units with the following type designation:

- DCU 002, Display Control Unit
- DCU 110, Display Control Unit with integrated power supply pack
- DCU 180, Display Control Unit with integrated power supply pack
- DCU 310, Display Control Unit with integrated power supply pack
- DCU 400, Display Control Unit with integrated power supply pack

1.2 Target group

This operating instructions are aimed at all persons performing the following activities on the product:

- transport,
- setup (installation),
- usage and operation,
- decommissioning,
- maintenance and cleaning,
- storage or disposal.

The work described in this document is only permitted to be performed by persons with the appropriate technical qualifications (expert personnel) or who have received the relevant training from Pfeiffer Vacuum.

1.3 Conventions

1.3.1 Instructions in the text

Usage instructions in the document follow a general structure that is complete in itself. The required action is indicated by an individual step or multi-part action steps.

Individual action step

A horizontal, solid triangle indicates the only step in an action.

- ▶ This is an individual action step.

Sequence of multi-part action steps

The numerical list indicates an action with multiple necessary steps.

1. Step 1
2. Step 2
3. ...

1.3.2 Pictographs

Pictographs used in the document indicate useful information.



Note



Tip

1.3.3 Stickers on the product

This section describes all the stickers on the product along with their meaning.

	<p>Rating plate (example) Rating plates of the devices are affixed to the housing where they can be clearly seen</p>
	<p>Test seal: The test seal provides information regarding additional certifications</p>

Tbl. 1: Stickers on the product

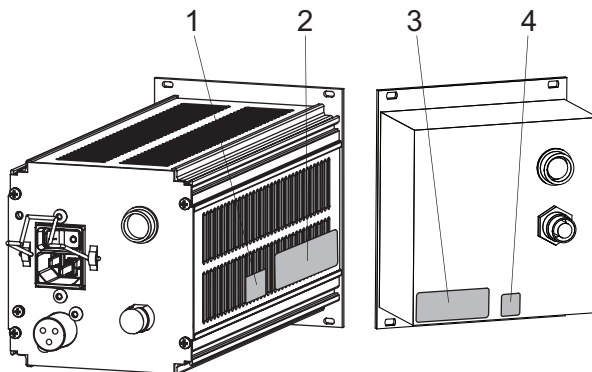

Fig. 1: Position of the labels on the product

- | | |
|---|------------------------|
| 1 CAN/USA test seal | 3 Rating plate for DCU |
| 2 Rating plate for DCU with power supply pack | 4 CAN/USA test seal |

1.3.4 Abbreviations

Abbreviation	Meaning in this document
AC	AC Voltage
APR	Piezo transmitter
CMR	Capacitive transmitter CMR
DC	Direct voltage, operating voltage
DCU	Display Control Unit
f	Rotation speed value of a vacuum pump (frequency, in rpm or Hz)
LC	Liquid crystal
LED	Illuminating diode
MPT	Pirani/Cold cathode transmitter

Abbreviation	Meaning in this document
PCR	Pirani/Capacitive transmitter
PKR	Pirani/Cold cathode transmitter
PPT	Pirani transmitter
[P:xxx]	Electronic drive unit control parameters. Printed in bold as three-digit number in square brackets. Frequently displayed in conjunction with a short description. Example: [P:312] software version
RS-485	Standard for a physical interface for asynchronous serial data transmission (Recommended Standard)
RPT	Piezo/Pirani transmitter RP
S1	Switch on power supply pack
T	Temperature (in °C)
TC	Turbopump electronic drive unit (turbo controller)
TPR	Pirani transmitter
TPS	Power supply pack, voltage supply (turbo power supply)
X3	Connecting socket for a Pfeiffer Vacuum transmitter

Tbl. 2: Abbreviations used in this document

2 Safety

2.1 General safety instructions

This document includes the following four risk levels and one information level.

⚠ DANGER
<p>Imminent danger</p> <p>Indicates a hazardous situation which, if not avoided, will result in death or serious injury.</p> <ul style="list-style-type: none"> ▶ Instructions on avoiding the hazardous situation

⚠ WARNING
<p>Possibly imminent danger</p> <p>Indicates a hazardous situation which, if not avoided, could result in death or serious injury.</p> <ul style="list-style-type: none"> ▶ Instructions on avoiding the hazardous situation

⚠ CAUTION
<p>Possibly imminent danger</p> <p>Indicates a hazardous situation which, if not avoided, could result in minor or moderate injury.</p> <ul style="list-style-type: none"> ▶ Instructions on avoiding the hazardous situation

NOTICE
<p>Danger of property damage</p> <p>Notice is used to address practices not related to physical injury.</p> <ul style="list-style-type: none"> ▶ Instructions on avoiding property damage

i	Notes, tips or examples indicate important information on the product or on this document.
----------	--

2.2 Safety instructions

All safety instructions in this document are based on the results of the risk assessment carried out in accordance with Low Voltage Directive 2014/35/EU. Where applicable, all life cycle phases of the product were taken into account.

Risks during installation

⚠ DANGER
<p>Danger to life from electric shock</p> <p>Contact with exposed and live elements generate an electric shock. Incorrect connection of the mains supply leads to the risk of live housing parts that can be touched. There is a risk to life.</p> <ul style="list-style-type: none"> ▶ Before the installation, check that the connection leads are voltage-free. ▶ Make sure that electrical installations are only carried out by qualified electricians. ▶ Provide adequate grounding for the device. ▶ After connection work, carry out an earthed conductor check.

⚠ DANGER**Danger to life from electric shock**

Power supply packs that are not specified or are not approved will lead to severest injuries up to death.

- ▶ Make sure that the power supply pack meets the requirements for double isolation between mains input voltage and output voltage, in accordance with IEC 61010 and IEC 60950.
- ▶ Make sure that the power supply pack meets the requirements in accordance with IEC 61010 and IEC 60950.
- ▶ Where possible, use original power supply packs or only power supply packs that correspond with the applicable safety regulations.

⚠ WARNING**Risk of danger to life through missing mains disconnection device**

The vacuum pump and electronic drive unit are **not** equipped with a mains disconnection device (mains switch).

- ▶ Install a mains disconnection device according to SEMI-S2.
- ▶ Install a circuit breaker with an interruption rating of at least 10,000 A.

⚠ WARNING**Danger to life from electric shock due to improperly performed installation**

The device uses voltage that is dangerous on contact as the electrical power supply. Potentially fatal situations arise due to unsafe or incorrectly installation when reaching into the device.

- ▶ Ensure that the system is safely integrated into an emergency off safety circuit.
- ▶ Do not carry out any unauthorized modifications or changes to the device.

Risks during operation**⚠ WARNING****Danger to life from electric shock in the event of a fault**

In the event of a fault, devices connected to the mains may be live. There is a danger to life from electric shock when making contact with live components.

- ▶ Always keep the mains connection freely accessible so you can disconnect it at any time.

Risks during maintenance**⚠ WARNING****Danger to life from electric shock during maintenance and service work**

The device is only completely de-energized when the mains plug has been disconnected and the vacuum pump is at a standstill. There is a danger to life from electric shock when making contact with live components.

- ▶ Before performing all work, switch off the main switch.
- ▶ Wait until the vacuum pump comes to a standstill (rotation speed =0).
- ▶ Disconnect all connection cables.
- ▶ Remove the mains plug from the device.
- ▶ Secure the device against unintentional restarting.

Risks during troubleshooting**⚠ WARNING****Danger to life from electric shock in the event of a fault**

In the event of a fault, devices connected to the mains may be live. There is a danger to life from electric shock when making contact with live components.

- ▶ Always keep the mains connection freely accessible so you can disconnect it at any time.

2.3 Safety precautions



Duty to provide information on potential dangers

The product holder or user is obliged to make all operating personnel aware of dangers posed by this product.

Every person who is involved in the installation, operation or maintenance of the product must read, understand, and adhere to the safety-related parts of this document.



Infringement of conformity due to modifications to the product

The Declaration of Conformity from the manufacturer is no longer valid if the operator changes the original product or installs additional equipment.

- Following installation into a system, the operator is required to check and re-evaluate as necessary the conformity of the overall system in the context of the relevant European Directives before commissioning that system.

General safety precautions when handling the product

- ▶ Use only power supply packs that comply with the applicable safety regulations.
- ▶ Observe all applicable safety and accident prevention regulations.
- ▶ Check that all safety measures are observed at regular intervals.
- ▶ Recommendation: Establish a secure connection to the earthed conductor (PE); protection class I.
- ▶ Never disconnect plug connections during operation.
- ▶ Keep lines and cables away from hot surfaces (> 70 °C).
- ▶ Do not carry out your own conversions or modifications on the unit.
- ▶ Observe the unit protection class prior to installation or operation in other environments.

2.4 Limits of use of the product

Installation location	weatherproof (internal space)
Air pressure	750 hPa to 1060 hPa
Installation altitude	max. 2000 m
Rel. air humidity	max. 80%, at T < 31°C, up to max. 50% at T < 40°C
Protection class	I
Permissible protection class	IP20
Ambient temperature	+5 ° to +50 °C

Tbl. 3: Permissible ambient conditions

2.5 Proper use

- The DCU Display Control Units are used exclusively for control of the electronic drive units for Pfeiffer Vacuum vacuum pumps and their accessories.
- The version with integrated power supply pack also supplies the operating voltage for the vacuum pump.

2.6 Foreseeable misuse

Improper use of the product invalidates all warranty and liability claims. Any use that is counter to the purpose of the product, whether intentional or unintentional, is regarded as misuse, in particular:

- Connection to the current supply that do not comply with the provisions of IEC 61010 or IEC 60950
- Operation with excessively high irradiated heat output
- Use in areas with ionizing radiation
- Operation in explosion-hazard areas
- Use of accessories or spare parts that are not listed in these instructions

3 Product description

3.1 Identifying the product

- ▶ To ensure clear identification of the product when communicating with Pfeiffer Vacuum, always keep all of the information on the rating plate to hand.
- ▶ Learn about certifications through test seals on the product or at www.certipedia.com with company ID no. 000024550.

3.2 Product features

Feature	DCU 002	DCU 110	DCU 180	DCU 310	DCU 400
Power supply pack	None	integrated	integrated	integrated	integrated
Power input	5 VA	130 VA	210 VA	340 VA	450 VA
Suitable for HiPace	all	10, 60, 80	300	300, 400, 700, 800	300, 400, 700, 800
Electronic drive unit	TC 110 TC 120 TC 400 TM 700 TC 1200	TC 110	TC 110	TC 400 (24 V DC)	TC 120 (48 V DC) TC 400 (48 V DC) TM 700

Tbl. 4: Product features

3.3 Shipment

- Display and control unit DCU
- Interface cable M12 to M12, 3 m in length
- Fixing materials
- Operating manual

3.4 Function

The DCU is a display and control unit for Pfeiffer Vacuum vacuum pumps with integrated electronic drive unit. This device provides an overview of all control parameters for the electronic drive unit. It is also possible to connect a pressure-measuring tube.

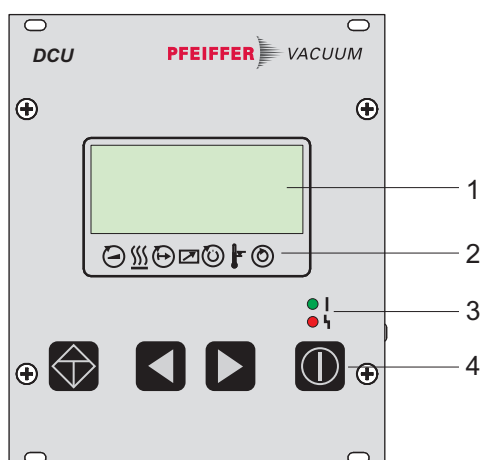

Fig. 2: DCU control panel, front view

- | | |
|---------------------------|------------------------------|
| 1 LC display, illuminated | 3 LED operating mode display |
| 2 Status symbols | 4 Controls |

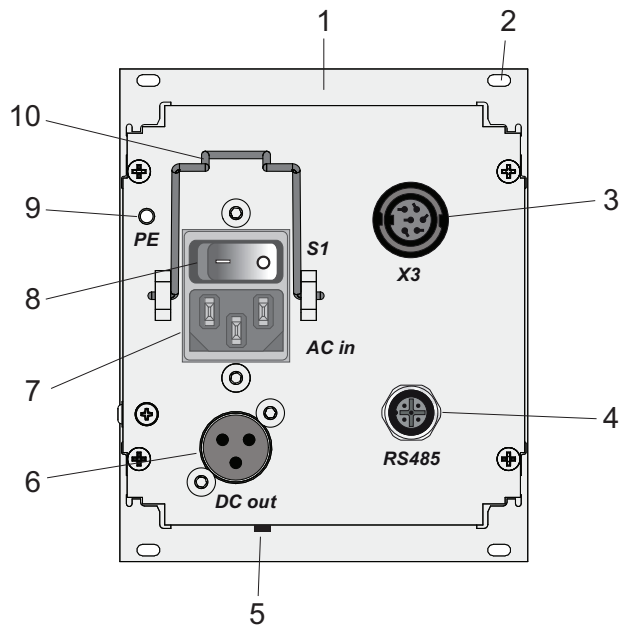

Fig. 3: DCU with integrated power supply pack, rear view

- | | | | |
|---|--------------------------|----|---------------------------------------|
| 1 | Front plate, rear side | 6 | Connecting socket DCOut |
| 2 | Mounting hole | 7 | Connecting plug ACin, mains input |
| 3 | Connecting socket X3 | 8 | Mains switch S1 |
| 4 | Connecting socket RS-485 | 9 | Earthed conductor, M4 |
| 5 | Contrast setting | 10 | Mounting bracket for mains connection |

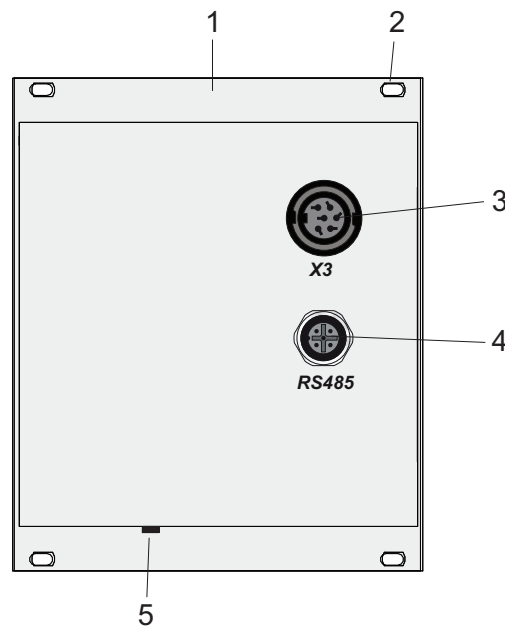







Fig. 4: DCU 002, rear view

- | | | | |
|---|------------------------|---|--------------------------|
| 1 | Front plate, rear side | 4 | Connecting socket RS-485 |
| 2 | Mounting hole | 5 | Contrast setting |
| 3 | Connecting socket X3 | | |

3.4.1 Key functions















4 short-stroke keys (softkeys) make up the user interface of the DCU.



Key	Parameter use	Description
	corresponds to [010] = 0 or 1	Pumping station ON/OFF: All components are put into/out of operation according to their configuration
		Error acknowledgement (Reset): Resets active malfunction messages in case the cause is eliminated.
	[308] --> [309]	Scroll forwards through the parameter set
	[309] --> [308]	Scroll back through the parameter set
	Press simultaneously	Editing mode: Allows the setting of parameter options The arrow - - - > designates the option selection in the display
	Press simultaneously again	Selection mode: Accepts the selection made ("change confirmed" is displayed)

Tbl. 5: Description of the key functions of the DCU

3.4.2 Status symbols

Status symbols under the LC-display visualize the current operating condition of the connected devices relative to essential parameters. Arrow representations in the lower display line provide visual information regarding status of the device.

Symbol	Parameter	Arrow representation	Explanation
	Vacuum pump accelerates = [P:307]	–	NO
			YES
	Preselection Heating = [P:001]	–	No preselection
			Preselection heating, switching point not reached
			Heating On, switching point reached
	Standby = [P:002]	–	OFF
			ON
	Equipment remote controlled = [P:300]	–	NO
			YES
	Switching point reached = [P:302]	–	NO
			YES
	Overtemperature	–	No overtemperatures
			Overtemperature vacuum pump = [P:305]
			Overtemperature electronic drive unit = [P:304]
			Overtemperature vacuum pump and electronic drive unit

Symbol	Parameter	Arrow representation	Explanation
	Final speed reached = [P:306]	–	NO
			YES

Tbl. 6: Status symbols and display on the DCU

4 Installation

4.1 Preparing for installation

General comments regarding installation

- ▶ Choose a site for installation where access to the product and to supply lines is possible at all times.
- ▶ Respect the ambient conditions stated for the area of use.
- ▶ A minimum distance of 50 mm from the upper cooling vents to adjacent components must be maintained

Installing the device

1. Install the device upright.
2. Ensure adequate cooling options.

4.2 Installing the device in a rack

NOTICE

Damage caused by overheating

The ambient temperature must not exceed the permissible operating temperature of the device.

- ▶ Make sure there is unobstructed circulation of air when installing the device.
- ▶ Make sure that air can enter and exit through the ventilation openings without obstruction.
- ▶ Do not cover the ventilation openings.
- ▶ Periodically check and clean the installed air filter.

The device is suitable for installation in a 19" mounting rack 3HE in accordance with DIN 41494.

Procedure

1. Install guide rails in the rack as required.
2. Push the device upright into the rack all the way to the front panel.
3. Secure the front panel with 4 collar screws and plastic nipples included in the shipment.

4.3 Connecting the electrical supply

⚠ DANGER

Danger to life from electric shock

Contact with exposed and live elements generate an electric shock. Incorrect connection of the mains supply leads to the risk of live housing parts that can be touched. There is a risk to life.

- ▶ Before the installation, check that the connection leads are voltage-free.
- ▶ Make sure that electrical installations are only carried out by qualified electricians.
- ▶ Provide adequate grounding for the device.
- ▶ After connection work, carry out an earthed conductor check.

⚠ WARNING

Risk of injury due to incorrect installation

Dangerous situations may arise from unsafe or incorrect installation.

- ▶ Do not carry out your own conversions or modifications on the unit.
- ▶ Ensure the integration into an Emergency Off safety circuit.

⚠ WARNING

Risk of danger to life through missing mains disconnection device

The vacuum pump and electronic drive unit are **not** equipped with a mains disconnection device (mains switch).

- ▶ Install a mains disconnection device according to SEMI-S2.
- ▶ Install a circuit breaker with an interruption rating of at least 10,000 A.

4.3.1 Connection diagram

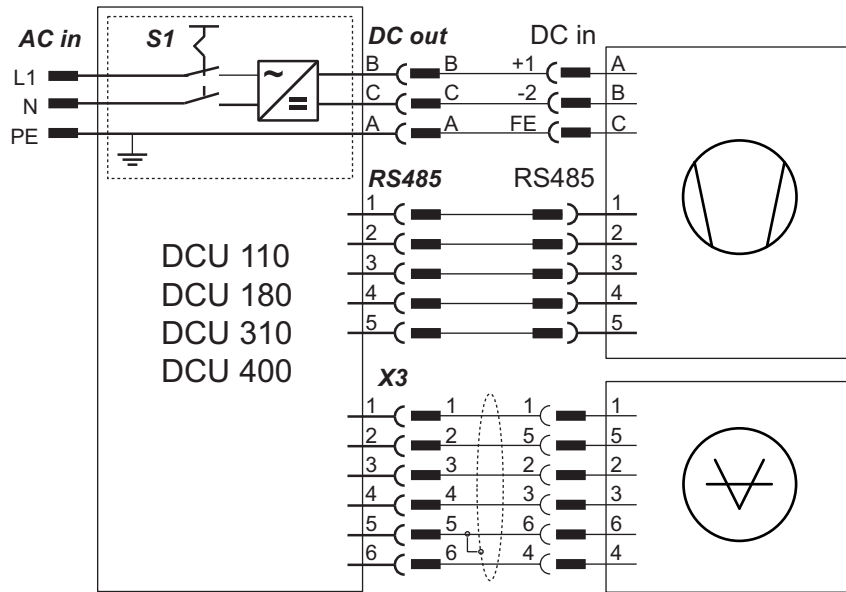

Fig. 5: Connection diagram for the DCU with integrated power supply pack

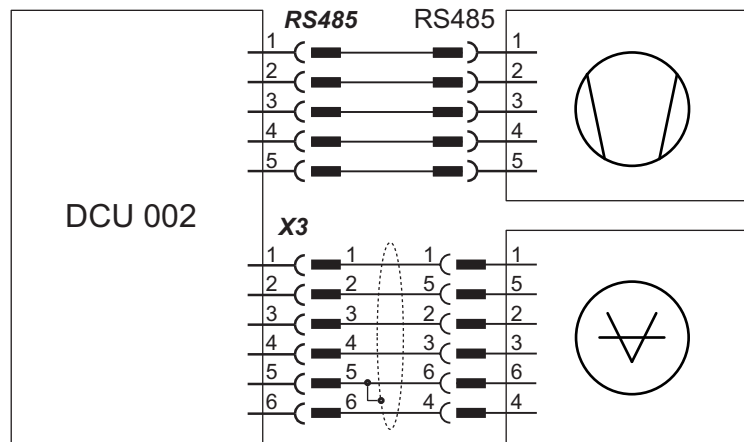

Fig. 6: Connection diagram for the DCU 002

Connection to:	DCU 002	DCU with integrated power supply pack
⊕ Vacuum pump with electronic drive unit	TC 110 TC 120 TC 400 TM 700 TC 1200	TC 110 TC 120 TC 400 TM 700
⊖ Transmitter type	TP/PCR PKR 2xx APR 250/260 CMR x61 – x65	TP/PCR PKR 2xx APR 250/260 CMR x61 – x65

Tbl. 7: Connection possibilities for electronic drive unit and transmitter



Connection selection at the electronic drive unit

The interface configuration for an electronic drive unit determines the connection options for the DCU.

- Connection to an electronic drive unit with multi-function connector via connection cable or via adapter from the Pfeiffer Vacuum accessories
- Connection to an electronic drive unit directly at an available RS-485 interface

4.3.2 Earthing the device

- The ground terminal is obligatory for DCUs with integrated power supply pack.
- Pfeiffer Vacuum recommends connecting a suitable grounding cable to the DCU 002 to discharge applicative interferences.
- Alternatively, the DCU 002 is grounded following installation in a rack.

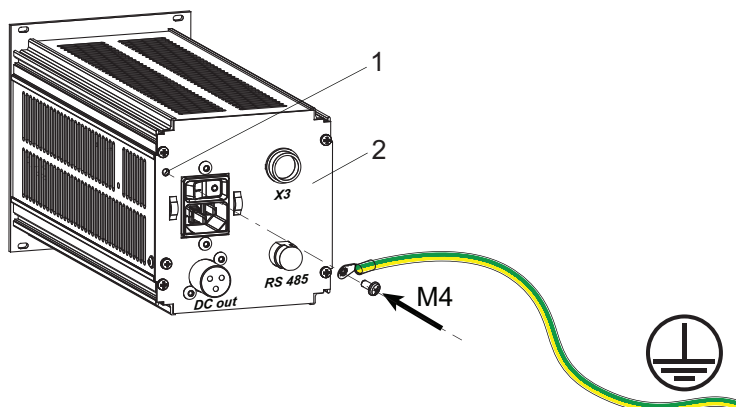

Fig. 7: Connection of the grounding cable to the DCU with integrated power supply pack

- 1 Ground terminal 2 Rear of housing

Procedure for DCU with integrated power supply pack

1. Use the ground terminal at the back of the device (M4 female thread).
2. Route the connection in accordance with locally applicable provisions.

4.3.3 Connect DCU to a vacuum pump

⚠ DANGER

Danger to life from electric shock

Power supply packs that are not specified or are not approved will lead to severest injuries up to death.

- ▶ Make sure that the power supply pack meets the requirements for double isolation between mains input voltage and output voltage, in accordance with IEC 61010 and IEC 60950.
- ▶ Make sure that the power supply pack meets the requirements in accordance with IEC 61010 and IEC 60950.
- ▶ Where possible, use original power supply packs or only power supply packs that correspond with the applicable safety regulations.



Observe the supreme operating control for the electronic drive unit interfaces

DIL switches in the connecting cable or bridges in the mating connector for the D-Sub connector for the electronic drive unit enable operation of the pump without control unit. This may cause priority conflicts with the RS-485 interface.

- Disconnect the mating connector from the "remote" connection prior to connecting a DCU to electronic drive unit TC 400, TC 1200 or TM 700.
- Switch off the supreme operating control (DIL switch S1/S2 = OFF) prior to connecting a DCU to the electronic drive unit TC 110

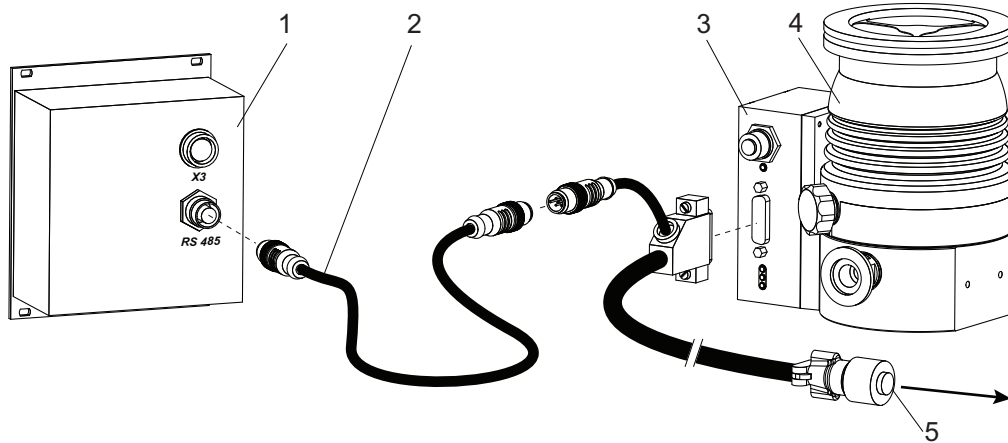

Fig. 8: Example: Connection of a DCU 002 to a vacuum pump

- | | |
|--------------------------------|--|
| 1 DCU 002 | 4 Turbopump HiPace 80 |
| 2 Interface cable M12 | 5 Connecting plug to power supply pack |
| 3 Electronic drive unit TC 110 | |

Connecting the DCU 002

The DCU 002 receives the supply voltage via the electronic drive unit interface. The RS485 serial interface of the DCU is used exclusively to control the electronic drive unit of a vacuum pump. The interface protocol is described in the operating manual of the respective electronic drive unit.

1. Connect the "RS-485" DCU connection with the electronic drive unit of the vacuum pump.
2. Use the interface cable M12 from the shipment.

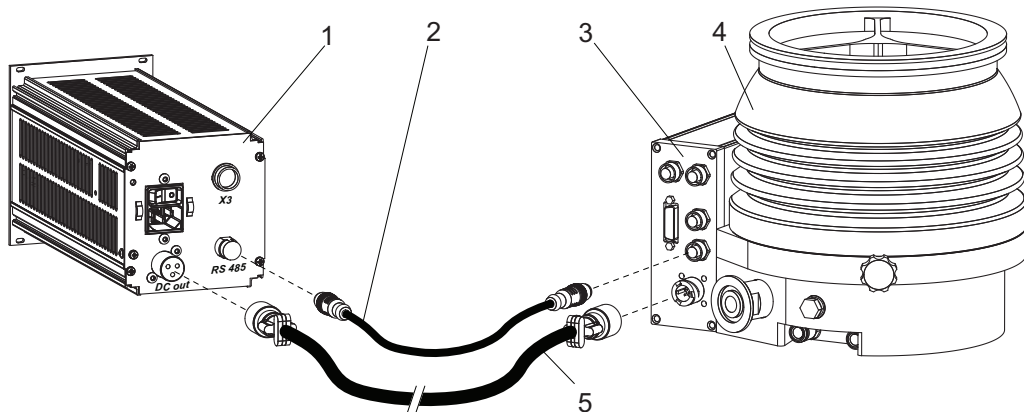

Fig. 9: Example: Connection of a DCU with integrated power supply pack to a vacuum pump

- | | |
|--------------------------------|-----------------------------|
| 1 DCU 002 | 4 Turbopump HiPace 700 |
| 2 RS-485 interface cable (M12) | 5 Supply voltage cable "DC" |
| 3 Electronic drive unit TC 400 | |

Connecting a DCU with integrated power supply pack

1. Make sure that the power supply pack main switch is off prior to connection.
2. Always ensure a secure connection to the earthed conductor (PE), protection class I.
3. Connect the "RS-485" DCU connection with the electronic drive unit of the vacuum pump.
4. Use the interface cable M12 from the shipment.
5. Connect the "DC out" connection of the DCU with the electronic drive unit of the vacuum pump as prescribed in the wiring diagram, or with a cable from the Pfeiffer Vacuum accessories.

4.3.4 Establishing mains connection

Only applicable for configurations with integrated power supply pack (DCU 110, DCU 180, DCU 310 and DCU 400). The DCU 002 receives the supply voltage via the electronic drive unit RS-485 interface.

Establishing mains connection for DCU

1. Make sure that the "S1" power supply pack master switch is off prior to connection.
2. Always ensure a secure connection to the earthed conductor (PE), protection class I.
3. Insert the mains connector cable (not included in the shipment) in the "AC in" mains connection plug at the rear side of the device.
4. Secure the connection with the mounting bracket.
5. Connect the mains cable to the mains power supply on the customer-side.

4.4 Connecting measuring tubes

The connecting socket with designation "X3" is used to connect a Pfeiffer Vacuum transmitter.

Measuring tubes	Display on the DCU [P:738]
APR 250/260	CMRx61
CMR 261/361	CMRx61, following manual selection
CMR 262/362	CMRx62, following manual selection
CMR 263/363	CMRx63, following manual selection
CMR 264/364	CMRx64, following manual selection
CMR 365	CMRx65, following manual selection
MPT 200 AR	PKR2xx
PCR 280	TP/PCR
PKR 251/261/360/361	PKR2xx
PPT 200 AR	TP/PCR
RPT 200 AR	TP/PCR
TPR 270/280/281	TP/PCR

Tbl. 8: Available Pfeiffer Vacuum transmitters for connection to a DCU

Procedure

1. Connect a pressure measuring tube to connection "X3" of the DCU as required.
2. The corresponding connection cable is available as a Pfeiffer Vacuum accessory.
3. Change the name of the transmitter as required by setting the parameter [P:738].

5 Parameter set

5.1 General

Important settings and function-related characteristics are factory-programmed into the electronic drive unit as parameters. Each parameter has a three-digit number and a description. The use of the parameter is possible via Pfeiffer Vacuum displays and control panels, or externally via RS-485 using Pfeiffer Vacuum protocol.

The vacuum pump starts in standard mode with factory default pre-set parameters.



Non-volatile data storage

When switching off or in the event of unintentional voltage drop, the **parameters** and the operating hours stay saved in the electronics.

#	Three digit number of the parameter
Display	Display of parameter description
Description	Brief description of the parameters
Functions	Function description of the parameters
Data type	Type of formatting of the parameter for the use with the Pfeiffer Vacuum protocol
Access type	R (read): Read access; W (write): Write access
Unit	Physical unit of the described variable
min./max.	Permissible limit values for the entry of a value
default	Factory default setting (partially pump-specific)
	The parameter can be saved non-volatile in the electronic drive unit

Tbl. 9: Explanation and meaning of the parameters

5.2 Additional parameter for the DCU



Additional parameter in the control panel

The basic parameter set is set in the electronic drive unit ex-factory. For controlling connected external components (e.g. vacuum measuring instruments), additional parameters (extended parameter set) are available in the corresponding Pfeiffer Vacuum display and control panels.

- Refer to the corresponding operating instructions of the respective components.
- Select the extended parameter set with parameter **[P:794] = 1**.

#	Display	Description	Functions	Data type	Access type	Unit	min.	max.	de-fault	
340	Pressure	Actual pressure value (ActiveLine)		7	R	hPa	$1 \cdot 10^{-10}$	$1 \cdot 10^3$		
350	Ctr Name	Display and control panel: type		4	R					
351	Ctr Software	Display and control panel: software version		4	R					
738	Gauge type	Type of pressure gauge		4	RW					

#	Display	Description	Functions	Data type	Access type	Unit	min.	max.	de-fault	
794	Param set	Parameter set	0 = Basic parameter set 1 = Extended parameter set	7	RW		0	1	0	
795	Servicelin	Insert service line		7	RW				795	

Tbl. 10: Parameter for DCU functions

5.3 Data types used

Data type	Description	Length l1 – l0	Example
0 – boolean_old	logical value (false/true)	06	000000 corresponds with false 111111 corresponds with true
1 – u_integer	pos. whole number	06	000000 to 999999
2 – u_real	pos. fixed-point number	06	001571 corresponds with 15.71
4 – string	Character string	06	TC_400, TM_700
6 – boolean_new	logical value (false/true)	01	0 corresponds with false 1 corresponds with true
7 – u_short_int	pos. whole number	03	000 to 999
10 – u_expo_new	pos. exponential value	06	100023 corresponds with $1.0 \cdot 10^3$
11 – string	Character string	16	this-is-an-example

6 Operation

6.1 LC-display

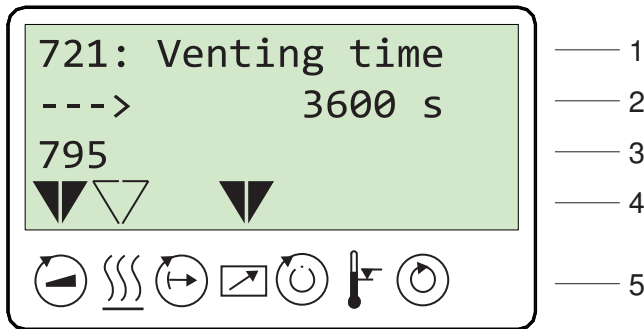

Fig. 10: LC-display, overview

The 4-line LC-display visualizes the functions of the DCU.

Line number	Function
Line 1	Number and name of the selected parameter (e.g. 721: Vent time).
Line 2	Relevant value for the selected parameter. The arrow \longrightarrow indicates Edit mode.
Line 3	has 2 functions: <ul style="list-style-type: none"> • Function 1: displays current messages, as well as messages pertaining to operation and control. • Function 2: presentation of a required second parameter in the format [Parameter number: value]. The function for this line can be set via parameter [P:795] Servicelin in Line 1. All parameters can be accessed with "Servicelin". Error messages will be displayed independently of the selected function.
Line 4	Presentation of the current equipment status with arrows which indicate the associated symbols.
Line 5	Symbols (see below)

Tbl. 11: Meaning of functions and layout of the LC-display

6.2 Switching on the DCU

⚠ WARNING

Danger to life from electric shock in the event of a fault

In the event of a fault, devices connected to the mains may be live. There is a danger to life from electric shock when making contact with live components.

- ▶ Always keep the mains connection freely accessible so you can disconnect it at any time.

Switching on the current supply at the DCU with integrated power supply pack

- ▶ Switch on the current supply with the S1 switch on the DCU.

Switching on the current supply at the DCU 002

- ▶ Switch on the current supply via the voltage supply for the vacuum pump.

The DCU carries out a self-test and a check of the connected units after switch-on. The duration of the self-test is indicated by a progress bar in the display, and takes around 20 seconds.

Test	Function
LC-display	All characters in the LC display go dark for a short time.
LED	The red and green LEDs illuminate during the self-test.
Hardware	–
Connection to the electronic drive unit	Request regarding correct connection to the electronic drive unit
Parameter check	The DCU loads the parameter set from the electronic drive unit
Identification of the connected devices	<ul style="list-style-type: none"> • Electronic drive unit designation display, • Transmitter designation display¹⁾.

Tbl. 12: Self-test, internal requests after switching on









- The green LED starts flashing when the self-test is complete. The DCU is ready for operation.

What to do in the event error messages appearing after switching on

1. Remove the cause of the fault (see chapter “Error codes”, page 29).
2. Reset the error messages by pressing the  key.

6.3 Displaying and configuring parameters with the DCU

Each parameter has a three-digit number and a description. The value of a parameter is always readable. Editable parameters are control commands and reference value inputs.

Function	Actuation	Effect
Select parameter	Preselect parameter number using the  (backwards) or  (forwards) keys Holding the respective key pressed will effect rapid scrolling	The selected parameter is displayed in Line 1, and the associated value in Line 2.
Set parameters	Press  and  keys simultaneously	<ul style="list-style-type: none"> • Edit mode for the selected parameter is active • An arrow (—▶) is displayed at the beginning of the second line in the LCD
Modify parameter value	Reduce or increase value with the keys  ,  , or change option.	
Acknowledge parameter	Press  and  keys simultaneously.	<ul style="list-style-type: none"> • Parameter for Line 1 is selected • Line 3 displays: "change confirmed" if no 2nd displayed value has been selected (see [P:795]) • Editing mode for the selected parameter is complete; the arrow (—▶) disappears

Tbl. 13: Selecting and setting parameters

Conditions for automatic termination of the Edit mode

- Input disruption or no key operation for more than 10 sec.
- Occurrence of an error
- Press the ON/OFF key.
- If Line 3 = empty, "data not changed" will be displayed.

1) A connected PCR 280 transmitter appears as "TPR" in the display.

6.4 Switching on the connected vacuum pump

The "pumping station" parameter **[P:010]** comprises operation of the vacuum pump with control of all connected accessory devices (e.g. backing pump).

Procedure

- ▶ Set the parameter **[P:010]** to "1".

Procedure

After successfully completing the self-test, the electronic drive unit resets pending and corrected error messages. The turbopump starts and all connected accessory devices start operation according to their configuration.

1. Set the parameter **[P:023]** to "1".
 - The parameter **[P:023]** switches on the motor of the turbopump.
2. Set the parameter **[P:010]** to "1".

6.5 Transmitter operation



Pressure measurement with the DCU

The DCU provides an approximate pressure reading. For the precise pressure measurement, and in particular for linear transmitters in the lower pressure range, [Pfeiffer Vacuum measuring instruments](#) are ideal.

Displaying active transmitters

The DCU detects transmitters with the same image incidences group.

1. Set the parameter **[P:794]** to "1" (display of extended parameter set).
2. Select the transmitter with parameter **[P:738]**.
3. Specify the exact designation of the transmitter with parameter **[P:738]** as required.

Display example	Meaning
TPR 2xx	Pirani transmitter TPR 280 connected
CMR ?	Transmitter of CMR group connected, exact type not yet specified
noGaug	No pressure gauge connected

Tbl. 14: Examples of displays for the transmitter

Display of actual pressure value

1. Set the parameter **[P:794]** to "1" (display of extended parameter set).
2. Display the current pressure measurement with parameter **[P:340]** (pressure).

Display example	Meaning
——— hPa	No pressure gauge connected
< 5E-4 hPa	Values below measuring range (depending on the device used)
> 1E3 hPa	Measuring range exceeded (depending on the device used)
6.3E-9 hPa	Valid pressure measurement
id fam hPa	Model not yet identified; see [P:340]
Error	Error in the transmitter

Tbl. 15: Examples of displays for the actual pressure value









6.6 Switching off the connected vacuum pump

Procedure

- ▶ Press the  key again and switch off a vacuum pump or a pumping station.

6.7 Operating mode display via LED

The LEDs on the front panel of the DCU display basic operating statuses.

LED	Symbol	LED status	Display	Meaning
Green 		Off	————	without current
		On, flashing		"Pumping station OFF", rotation speed \leq 60 rpm
		On, inverse flashing		"Pumping station ON", set rotation speed not reached
		On, constant		"Pumping station ON", set rotation speed reached
		On, flashing		"Pumping station OFF", rotation speed $>$ 60 rpm
Red 	⚡	Off	————	no error, no warning
		On, flashing		Warning
		On, constant		Defect

Tbl. 16: LED display and meaning at the DCU

6.8 Switching off the DCU

Switching off DCU 002

The power supply pack connected for the vacuum pump supplies the DCU 002 with operating voltage via the electronic drive unit.

1. Disconnect the voltage supply at the power supply pack of the vacuum pump.
 - Vacuum pumps which produce a generator current as the pump system runs down maintains supply of the DCU 002 until the current supply is disconnected.
2. Disconnect the power supply pack from the mains to disconnect the current supply completely.

Switching off the DCU with integrated power supply pack

1. Switch off the device at the back with the "S1" switch.
2. Disconnect the DCU from the mains to disconnect the current supply completely.

7 Maintenance

WARNING

Danger to life from electric shock during maintenance and service work

The device is only completely de-energized when the mains plug has been disconnected and the vacuum pump is at a standstill. There is a danger to life from electric shock when making contact with live components.

- ▶ Before performing all work, switch off the main switch.
- ▶ Wait until the vacuum pump comes to a standstill (rotation speed =0).
- ▶ Disconnect all connection cables.
- ▶ Remove the mains plug from the device.
- ▶ Secure the device against unintentional restarting.

The display and control unit cannot be repaired. In the event of a defect, replace the entire device with a replacement part.

8 Malfunctions

8.1 General

Vacuum pump and electronic drive unit malfunctions always result in a warning or error message. In both cases, the LC-display on the DCU shows an error code. LED on the electronic drive unit and on the DCU illuminate for the corresponding status.



No LC-display

- Absence of the LC-display is possibly an indication that attachment of the connection cable is faulty:
 - "DCout"
 - "RS485"
 - "X3"
 - "ACin"

8.2 Error codes

In addition to the device-specific warning and error messages for an electronic drive unit, the DCU also features its own messages. Errors (** Error E— **) always cause the connected peripheral devices to be switched off. Warnings (* Warning F — *) do not cause components to be switched off.

Handling malfunction messages

1. Read out the error codes via the display and control panel or the PC.
2. Remove the cause of the malfunction.
3. Reset the error message with parameter **[P:009]** or by pressing the button  on the DCU.

Display in DCU	Problem	Possible causes	Remedy
* Warning F110 *	Pressure gauge	<ul style="list-style-type: none"> • Pressure gauge faulty • Connection to the pressure gauge disconnected during operation 	<ul style="list-style-type: none"> • Check the cable connection • Carry out a restart with pressure gauge connected • Replace the pressure gauge completely
** Error E040 **	Hardware error	<ul style="list-style-type: none"> • external RAM faulty 	<ul style="list-style-type: none"> • Contact Pfeiffer Vacuum Service.
** Error E042 **	Hardware error	<ul style="list-style-type: none"> • EPROM checksum incorrect 	<ul style="list-style-type: none"> • Contact Pfeiffer Vacuum Service.
** Error E043 **	Hardware error	<ul style="list-style-type: none"> • ²EPROM write error 	<ul style="list-style-type: none"> • Contact Pfeiffer Vacuum Service.
** Error E090 **	Internal device error	<ul style="list-style-type: none"> • RAM not large enough • DCU is connected to incorrect electronic drive unit 	<ul style="list-style-type: none"> • Contact Pfeiffer Vacuum Service. • Connect the DCU to the correct electronic drive unit
** Error E698 **	Communication error	<ul style="list-style-type: none"> • Electronic drive unit is not responding 	<ul style="list-style-type: none"> • Contact Pfeiffer Vacuum Service.

Tbl. 17: Warning and error messages when using the DCU

9 Service solutions from Pfeiffer Vacuum

We offer first class service

Long vacuum component service life, coupled with low downtimes, are clear expectations that you have of us. We satisfy your needs with capable products and outstanding service.

We are consistently striving to perfect our core competence, service for vacuum components. And our service is far from over once you've purchased a product from Pfeiffer Vacuum. It often enough really just begins then. In proven Pfeiffer Vacuum quality, of course.

Our professional sales engineers and service technicians stand ready to provide hands-on support to you worldwide. Pfeiffer Vacuum offers a complete portfolio of service offerings, ranging from genuine spare parts right through to service agreements.

Take advantage of Pfeiffer Vacuum Service

Whether for preventative on-site service from our field service, fast replacement with as-new replacement products or repair in a Service Center close to you; you have various options for upholding your equipment availability. Detailed information and addresses can be found on our website in the Pfeiffer Vacuum Service section.

Advice on the optimum solution is available from your Pfeiffer Vacuum contact partner. For quick and smooth handling of the service process, we recommend the following steps:



1. Download the current form templates.
 - Declaration of Service Request
 - Service Request
 - Declaration of Contamination

- a. Dismantle all accessories and keep them (all external mounted parts as valve, inlet screen, etc.).
- b. Drain the operating fluid/lubricant as necessary.
- c. Drain the cooling medium as necessary.



2. Fill out the service request and the declaration of contamination.



3. Send the forms via email, fax or post to your local Service Center.



4. You will receive a response from Pfeiffer Vacuum.

PFEIFFER VACUUM

Sending of contaminated products

No units will be accepted if they are contaminated with micro-biological, explosive or radioactive substances. If products are contaminated or if the declaration of contamination is missing, Pfeiffer Vacuum will contact the customer before starting maintenance. In addition, depending on the product and the level of contamination **additional decontamination costs** may be required.

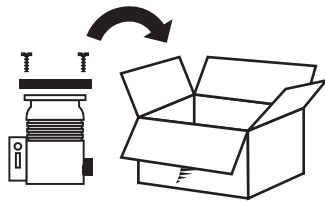

5. Prepare the product for transport in accordance with the details in the declaration of contamination.
 - a) Neutralize the product with nitrogen or dry air.
 - b) Close all openings with airtight blank flanges.
 - c) Seal the product in appropriate protective film.
 - d) Only pack the product in suitable, stable transport containers.
 - e) Observe the applicable transport conditions.

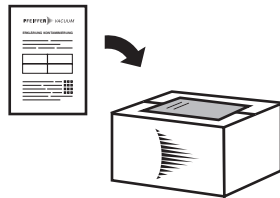

6. Affix the declaration of contamination to the **outside** of the packaging.

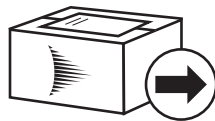

7. Then send your product to your local [Service Center](#).

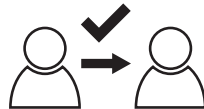

8. You will receive a confirmation message/a quotation from Pfeiffer Vacuum.

PFEIFFER VACUUM

For all service orders, our [General Terms and Conditions of Sales and Supply](#) and [General Terms and Conditions of Repair and Maintenance](#) apply to vacuum equipment and components.

10 Accessories



Please refer to the accessories list for the individual components in their respective operating manual or online at pfeiffer-vacuum.de.

11 Technical data and dimensions

11.1 Technical data

Selection field	DCU 002, Display Control Unit
Order number	PM 061 348 -T
Connection	12 – 30 V DC
Power consumption	5 VA
Protection category	IP20
Ambient temperature	5 – 50 °C
Weight	0.4 kg

Tbl. 18: DCU 002

Selection field	DCU 110, Display control unit with power supply pack	DCU 180, Display control unit incl. power supply pack 19"
Order number	PM C01 820	PM C01 821
Mains requirement: voltage (range)	115–230 (-20+15 %) V AC	115–230 (-20 – +15 %) V AC
Mains requirement: frequency (range)	50/60 Hz	50/60 Hz
Mains requirement: power consumption	130 VA	210 VA
Output current	4.6 A	7.5 A
Output voltage	24 (± 2 %) V DC	24 (± 2 %) V DC
Protection category	IP20	IP20
Ambient temperature	5 – 50 °C	5 – 50 °C
Weight	1.2 kg	1.7 kg

Tbl. 19: DCU 110, DCU 180

Selection field	DCU 310, Display control unit with power supply pack	DCU 400, Display control unit incl. power supply pack 19"
Order number	PM C01 822	PM C01 823
Mains requirement: voltage (range)	115–230 (-20+15 %) V AC	115–230 (-20+15 %) V AC
Mains requirement: frequency (range)	50/60 Hz	50/60 Hz
Mains requirement: power consumption	340 VA	450 VA
Output current	12.5 A	8.4 A
Output voltage	24 (± 2 %) V DC	48 (± 2 %) V DC
Protection category	IP20	IP20
Ambient temperature	5 – 50 °C	5 – 50 °C
Weight	1.85 kg	2.3 kg

Tbl. 20: DCU 310, DCU 400

11.2 Dimension drawings

All dimensions in mm

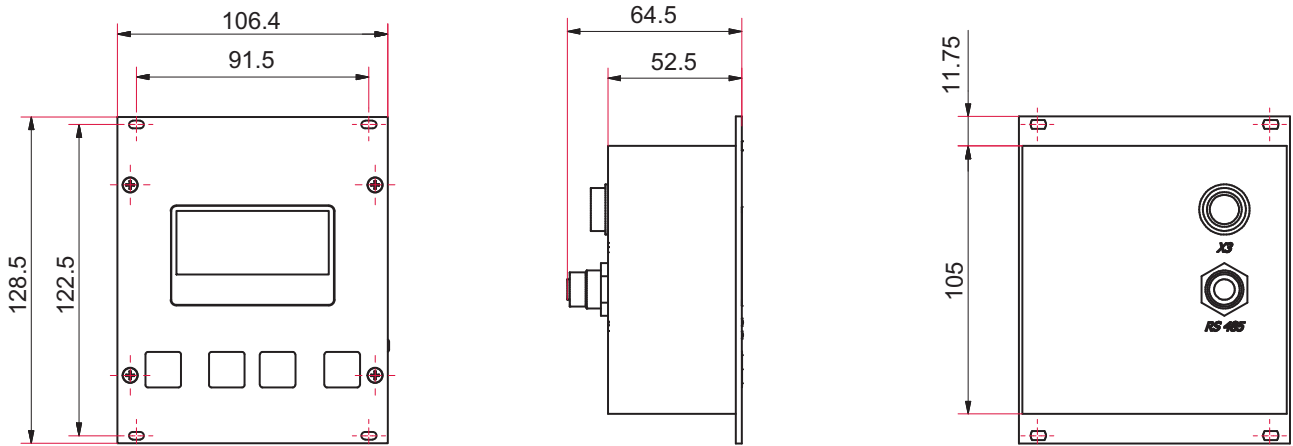

Fig. 11: Dimensions DCU 002

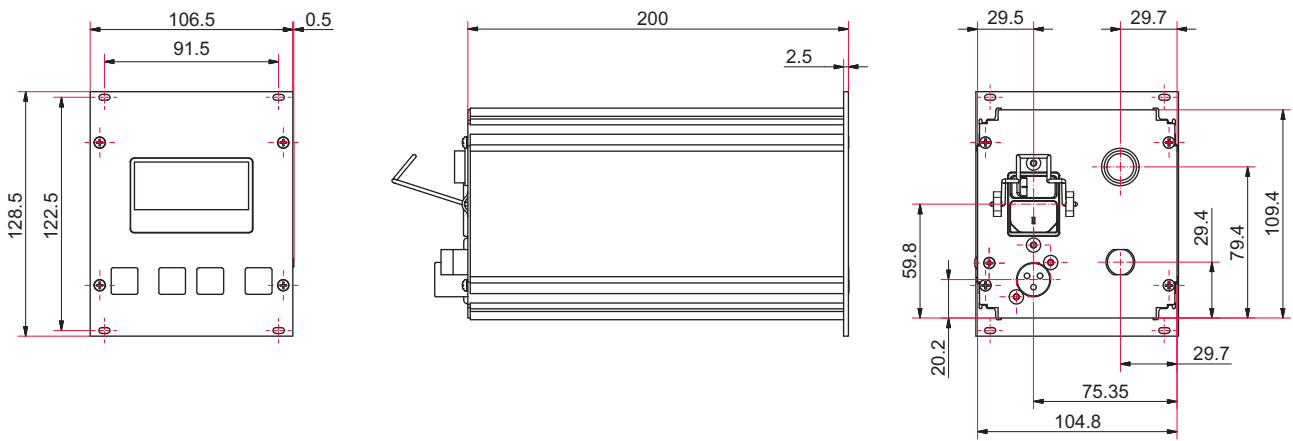

Fig. 12: Dimensions DCU 110

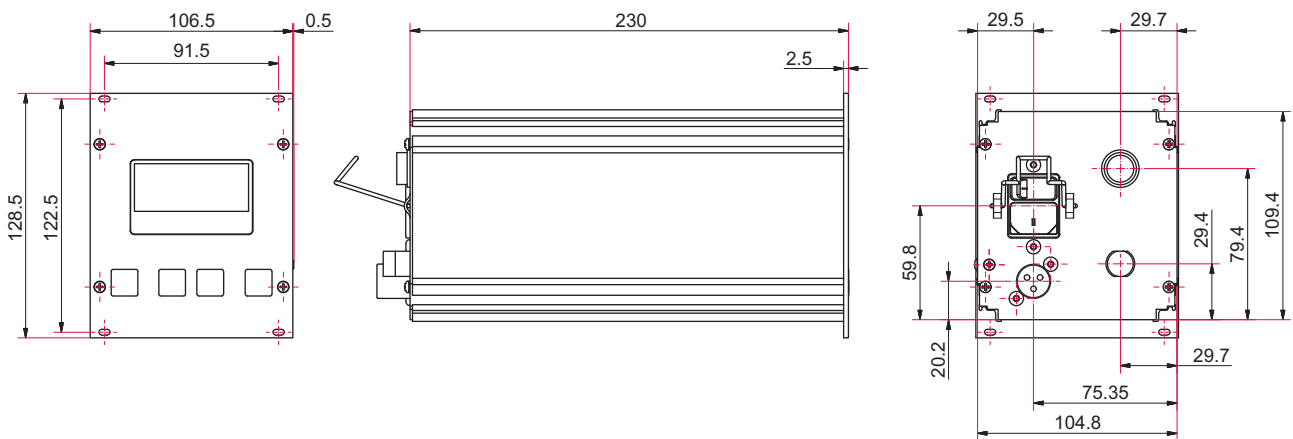

Fig. 13: Dimensions DCU 180, DCU 310, DCU 400

Declaration of conformity

We hereby declare that the product cited below satisfies all relevant provisions of the following EC Directives:

- **Electromagnetic compatibility 2014/30/EU**
- **Low voltage 2014/35/EC**
- **Restriction of the use of certain hazardous substances 2011/65/EU**

DCU 002

DCU 110 | DCU 180 | DCU 310 | DCU 400

Harmonized standards and applied national standards and specifications:

DIN EN 61000-3-2 : 2014

DIN EN 61000-3-3 : 2013

DIN EN 61010-1 : 2011

DIN EN 61326-1 : 2013

DIN EN 62061 : 2013

Semi F47-0200

Semi S2-0706

Signature:



Pfeiffer Vacuum GmbH
Berliner Straße 43
35614 Asslar
Germany

(Dr. Ulrich von Hülsen)
Managing Director

8/15/2018



VACUUM SOLUTIONS FROM A SINGLE SOURCE

Pfeiffer Vacuum stands for innovative and custom vacuum solutions worldwide, technological perfection, competent advice and reliable service.

COMPLETE RANGE OF PRODUCTS

From a single component to complex systems:

We are the only supplier of vacuum technology that provides a complete product portfolio.

COMPETENCE IN THEORY AND PRACTICE

Benefit from our know-how and our portfolio of training opportunities!

We support you with your plant layout and provide first-class on-site service worldwide.

ed. H - Date 1904 - P/N:PT0250BEN



Are you looking for a
perfect vacuum solution?
Please contact us

Pfeiffer Vacuum GmbH
Headquarters • Germany
T +49 6441 802-0
info@pfeiffer-vacuum.de

www.pfeiffer-vacuum.com

PFEIFFER  **VACUUM**